

生輔組工作流程圖

1. 學生生活輔導相關辦法擬訂事項

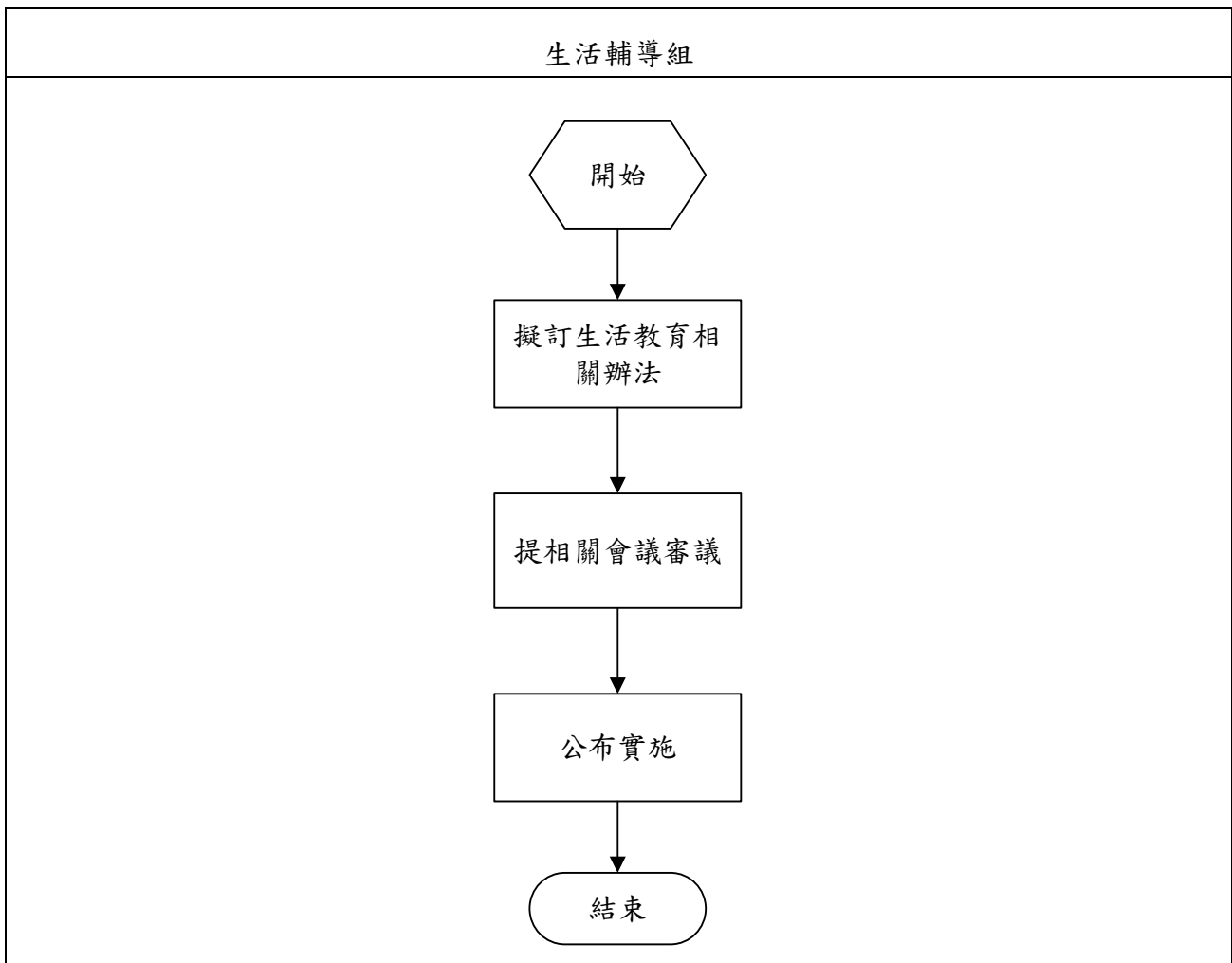

2. 導師業務之策劃與推行事項

(1) 導師業務之策劃與推行作業流程圖

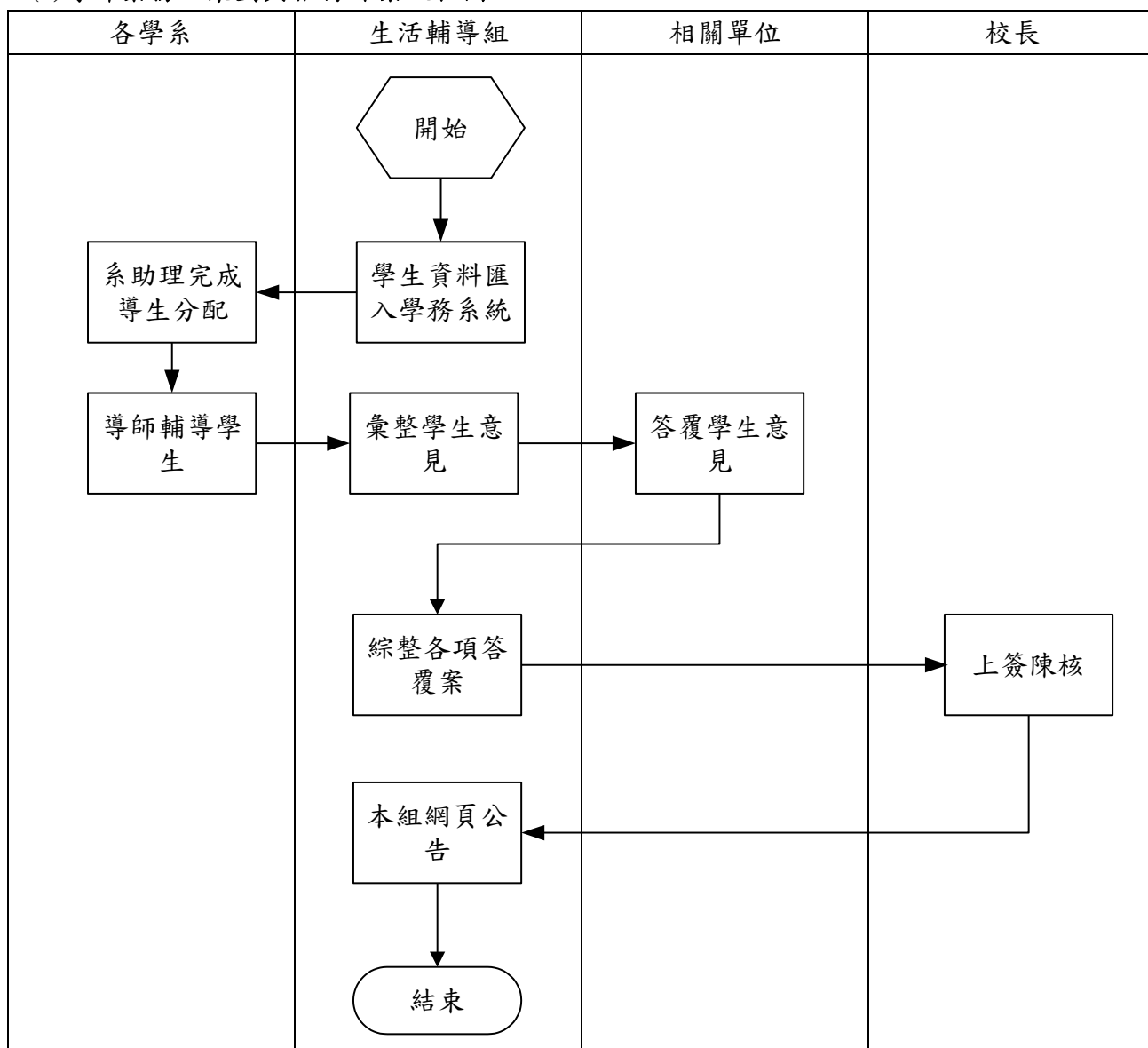

II. 導師輔導次數與考評表陳核作業流程圖

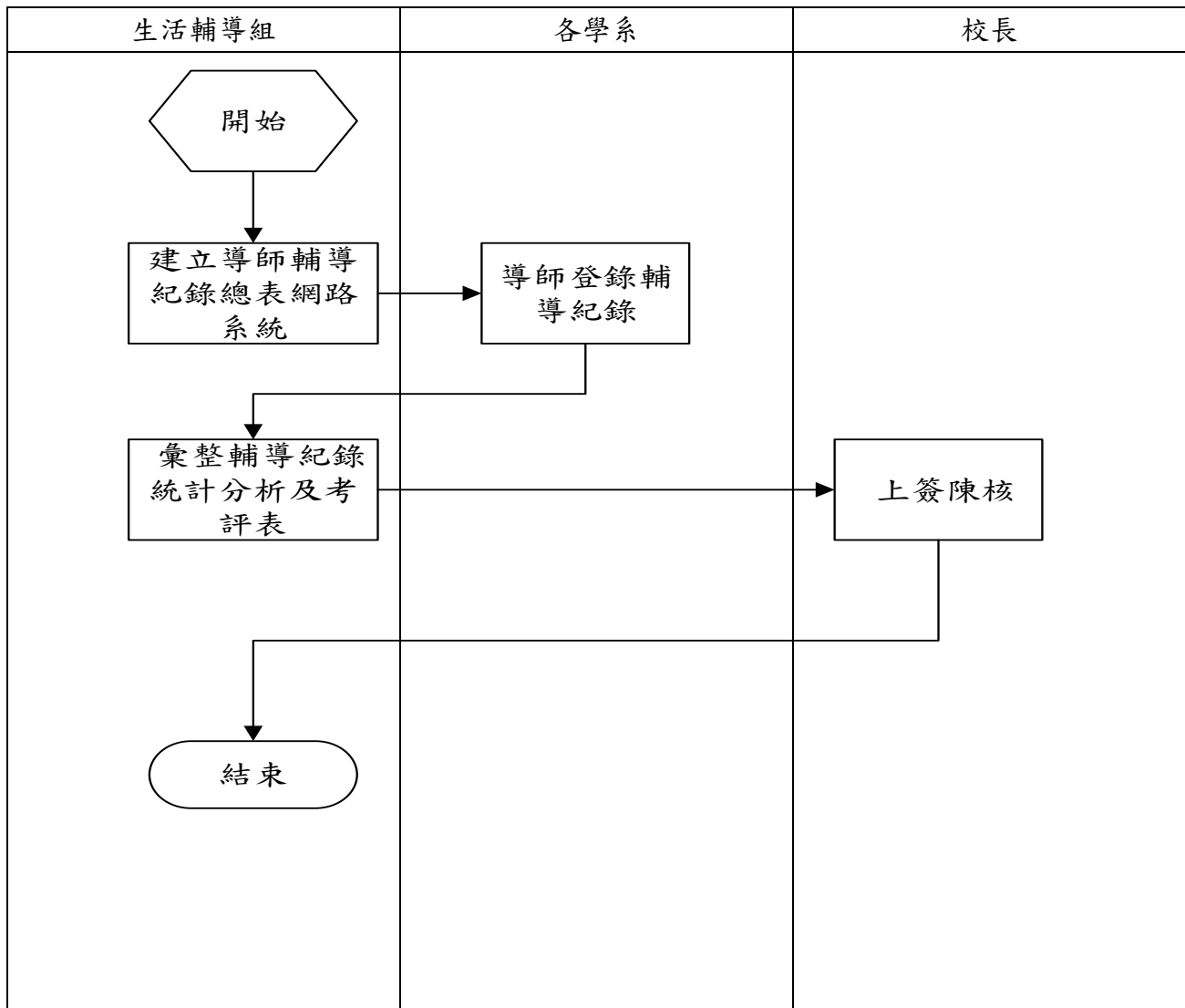

3. 學生生活教育規劃與執行事項

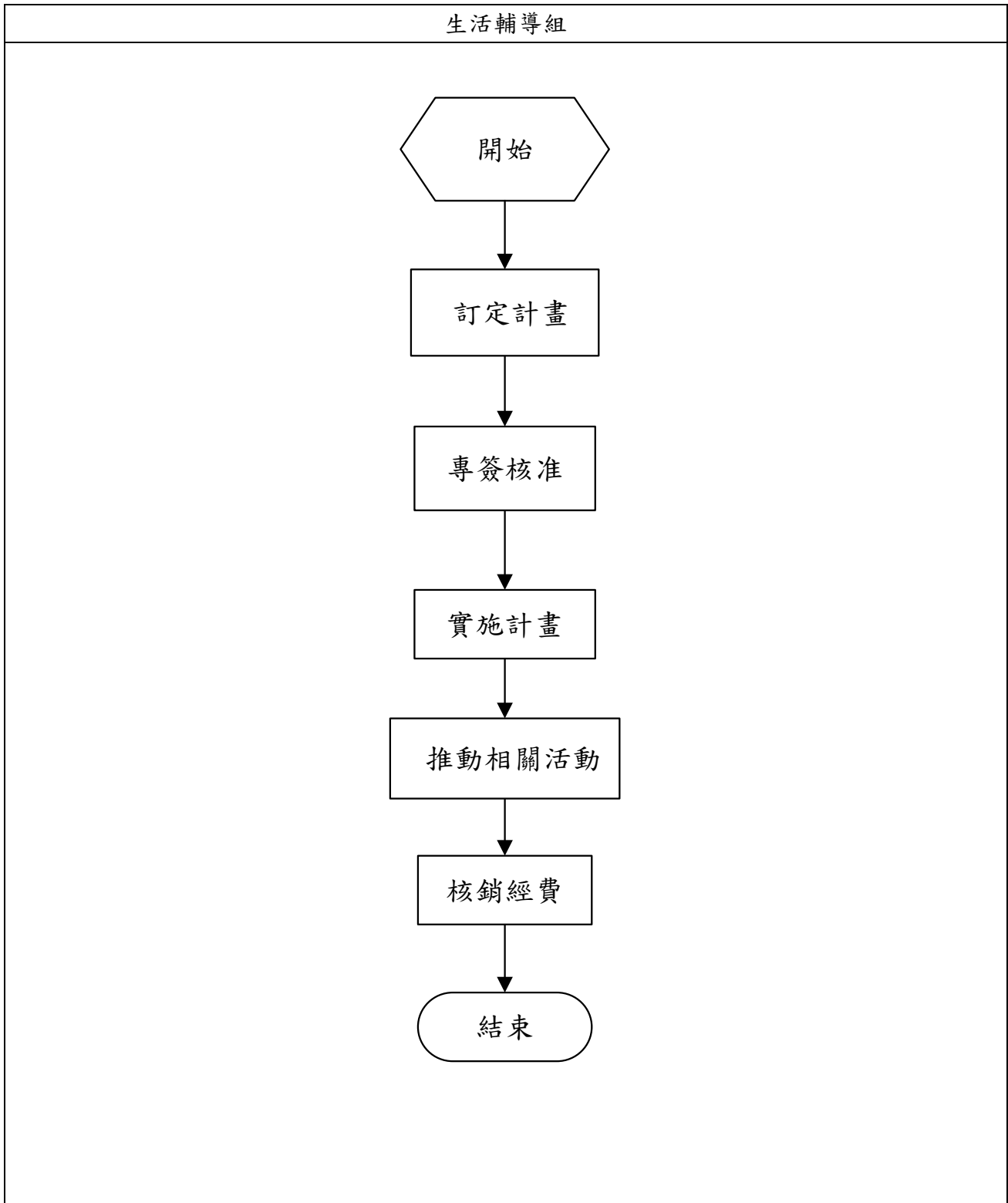

4. 優秀青年選拔事項

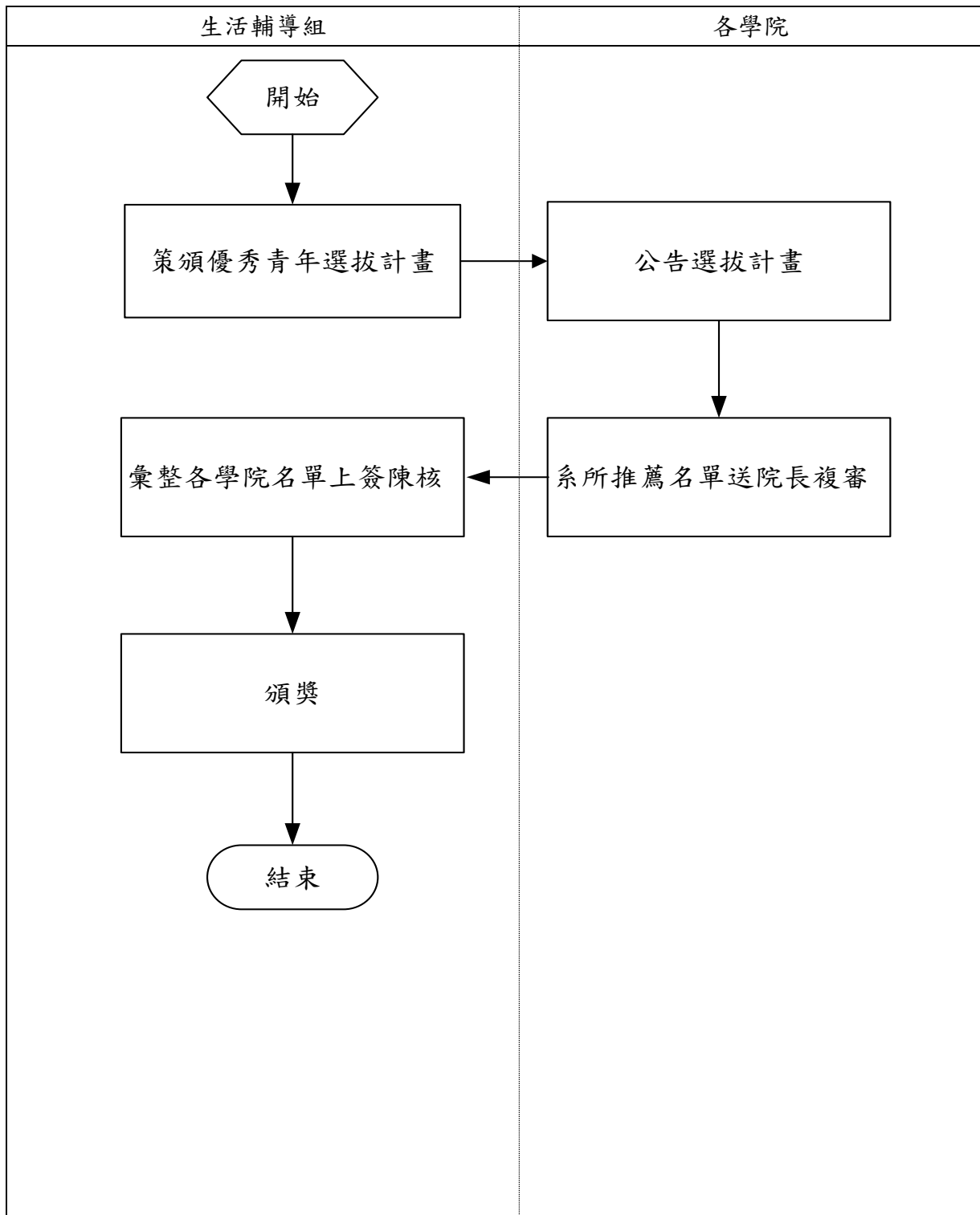

5. 學生獎助學金(含工讀金)事項

I. 弱勢助學金申請作業流程圖

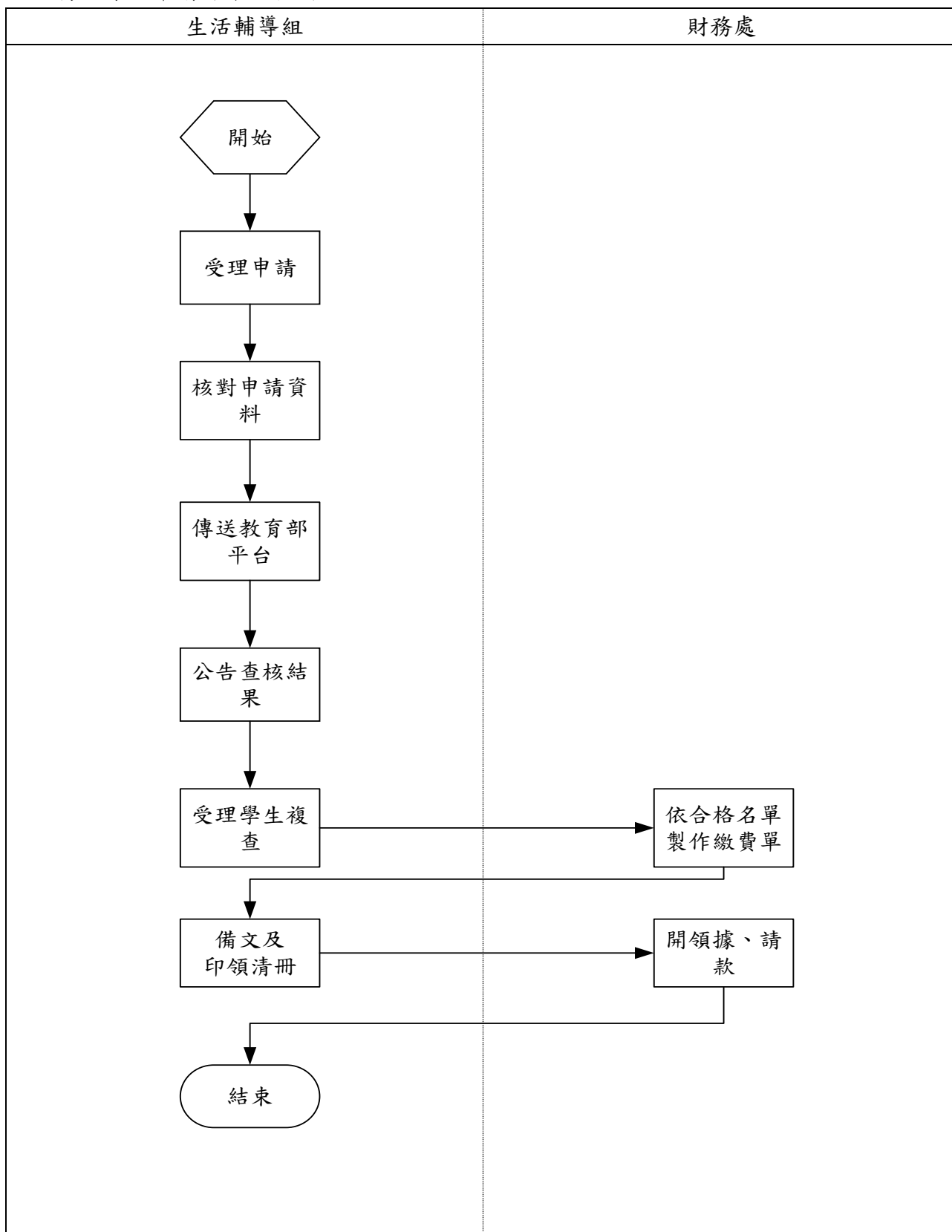

II. 一般工讀金及服務小組長工讀金作業流程圖

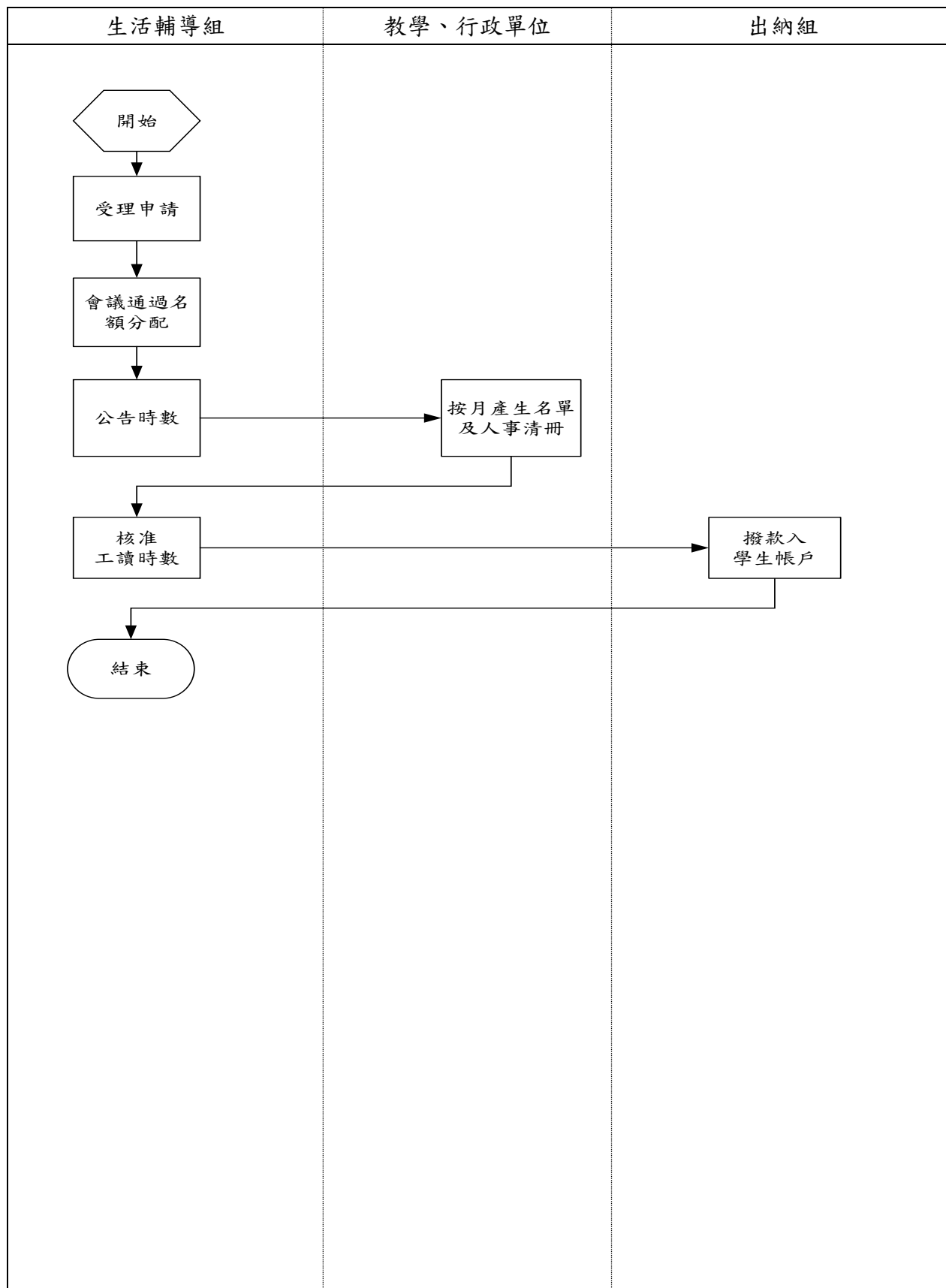

III. 清寒助學金作業流程圖

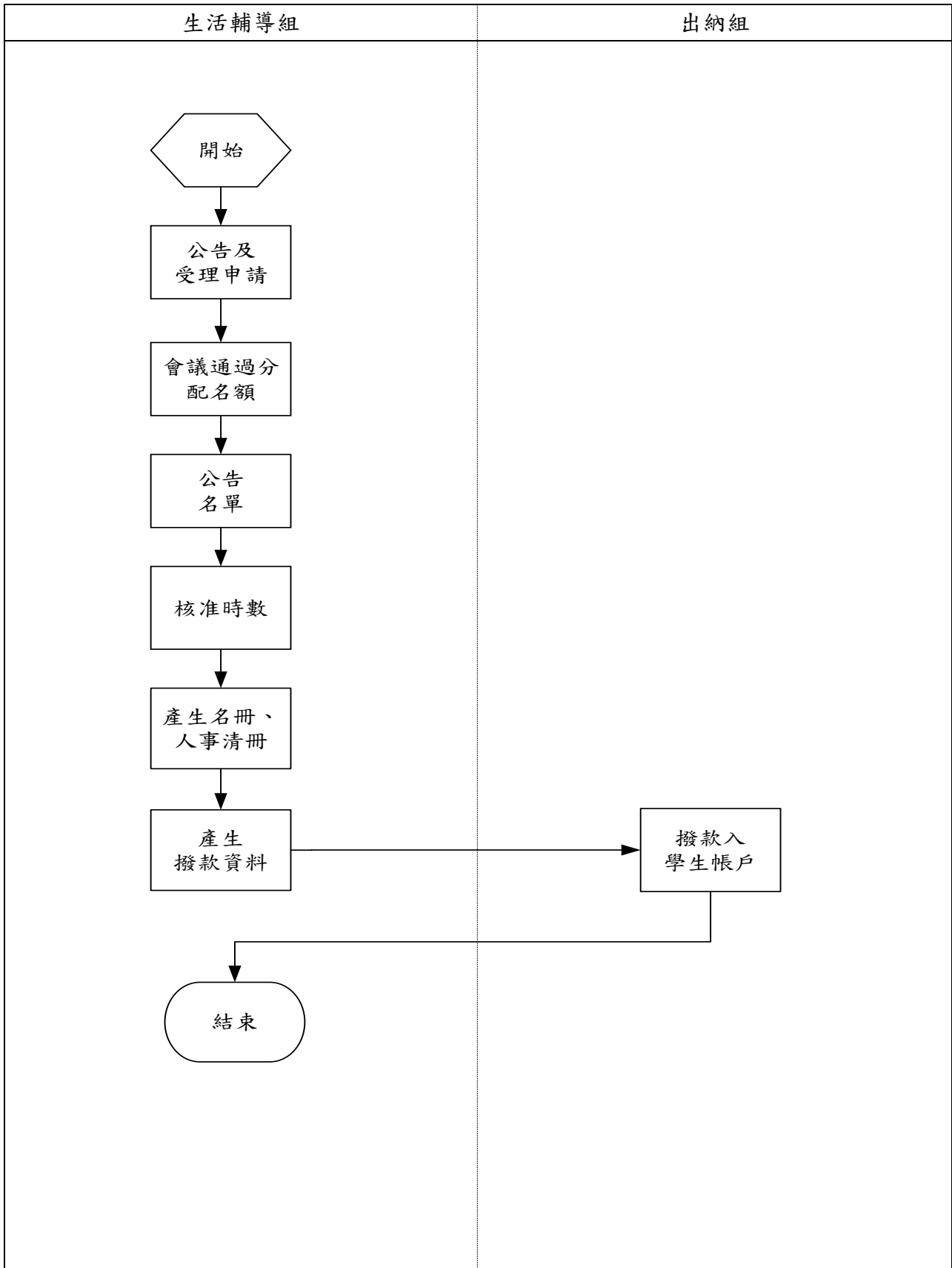

IV.原住民助學金作業流程圖

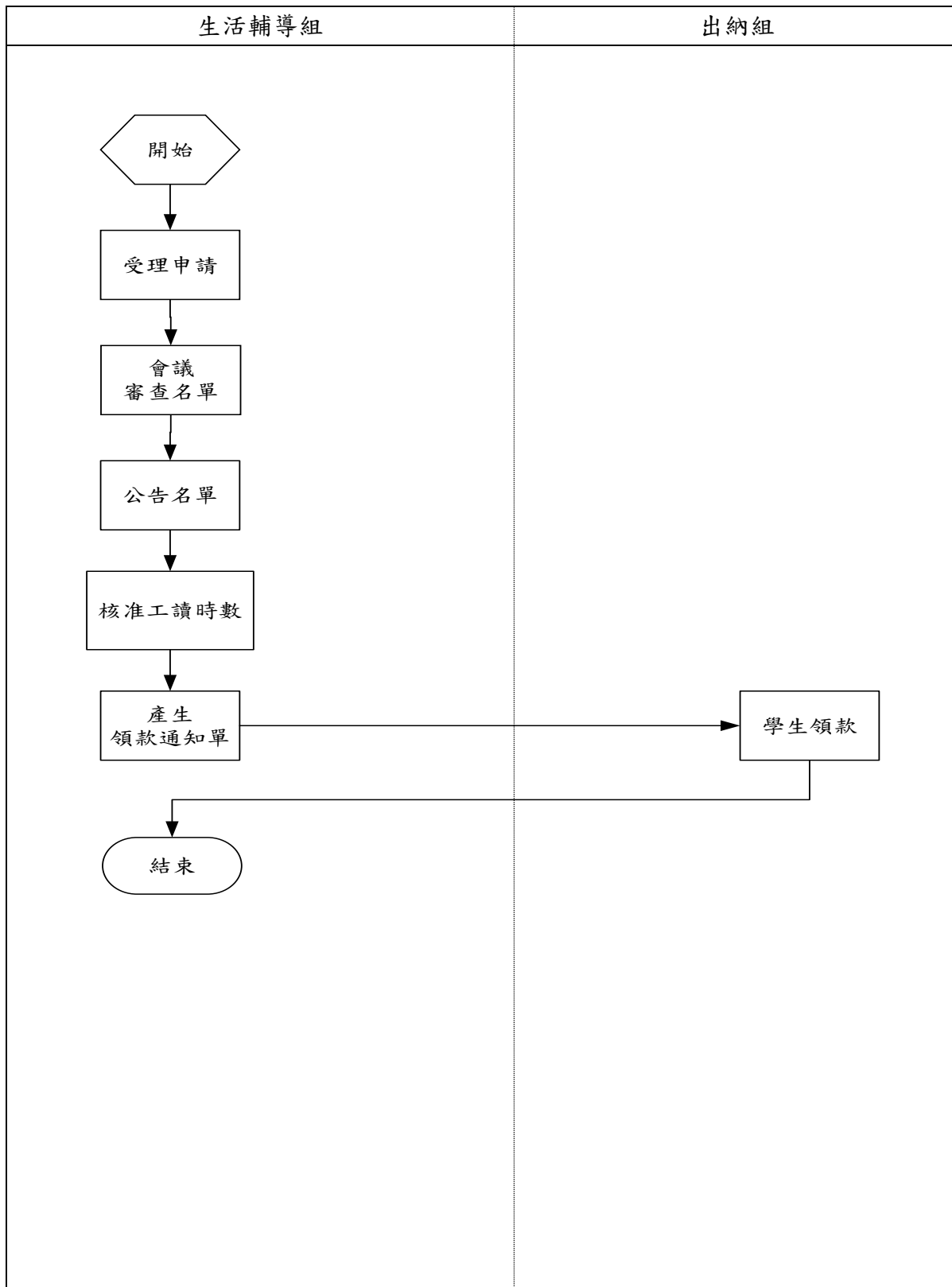

V.生活助學金作業流程圖

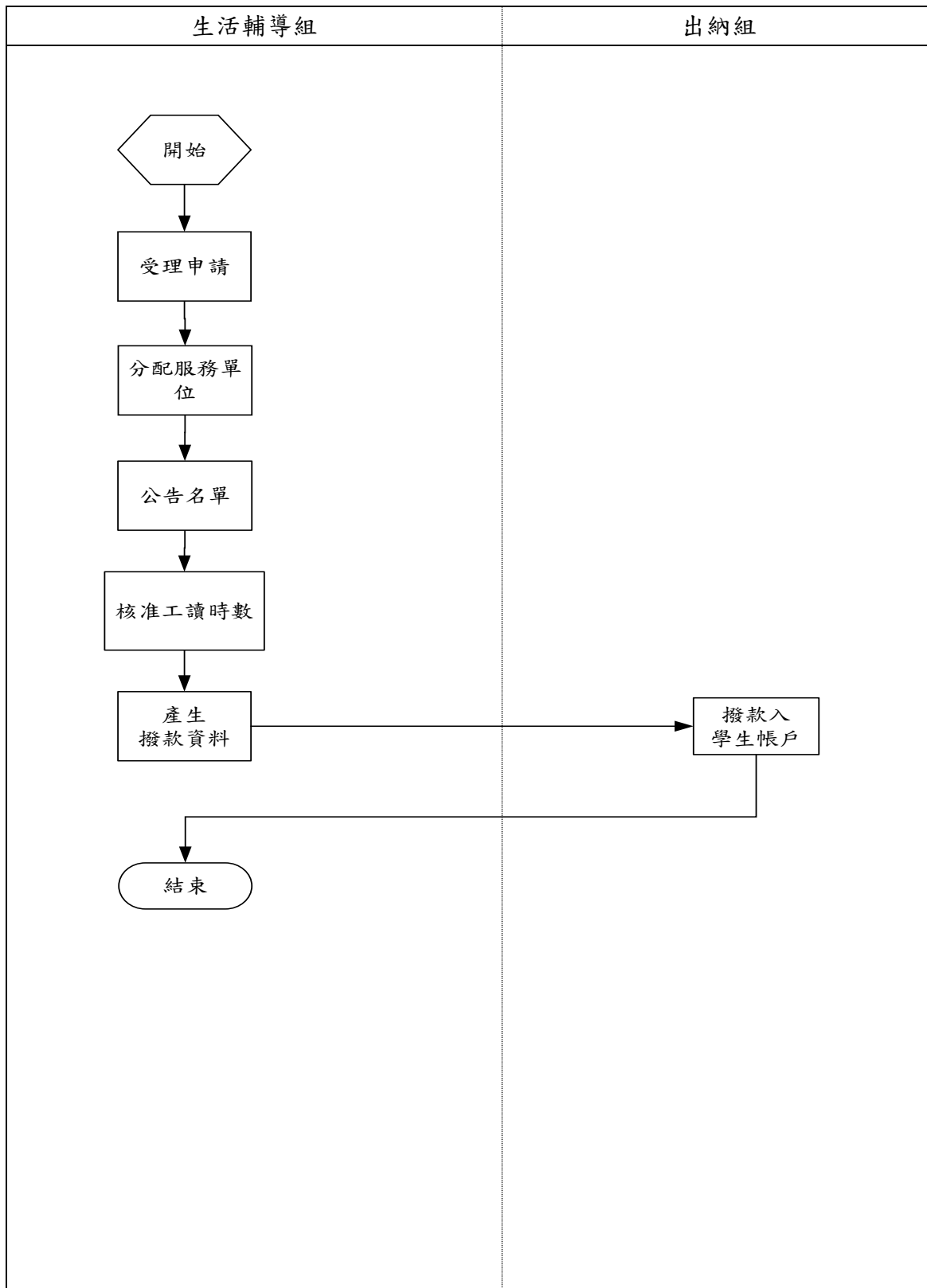

VI.課業輔導助學金作業流程圖

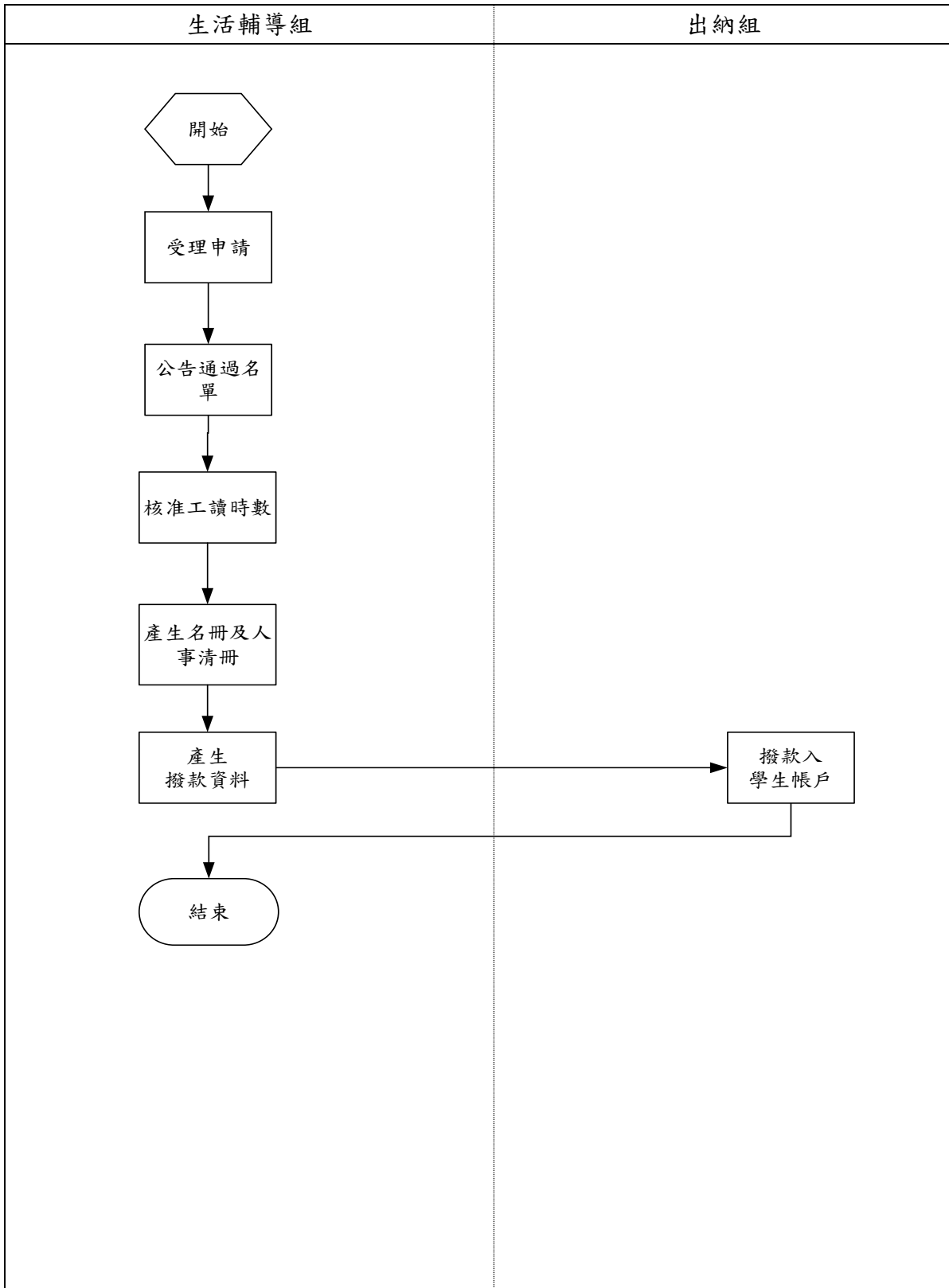

VII. 研究生助學金作業流程圖

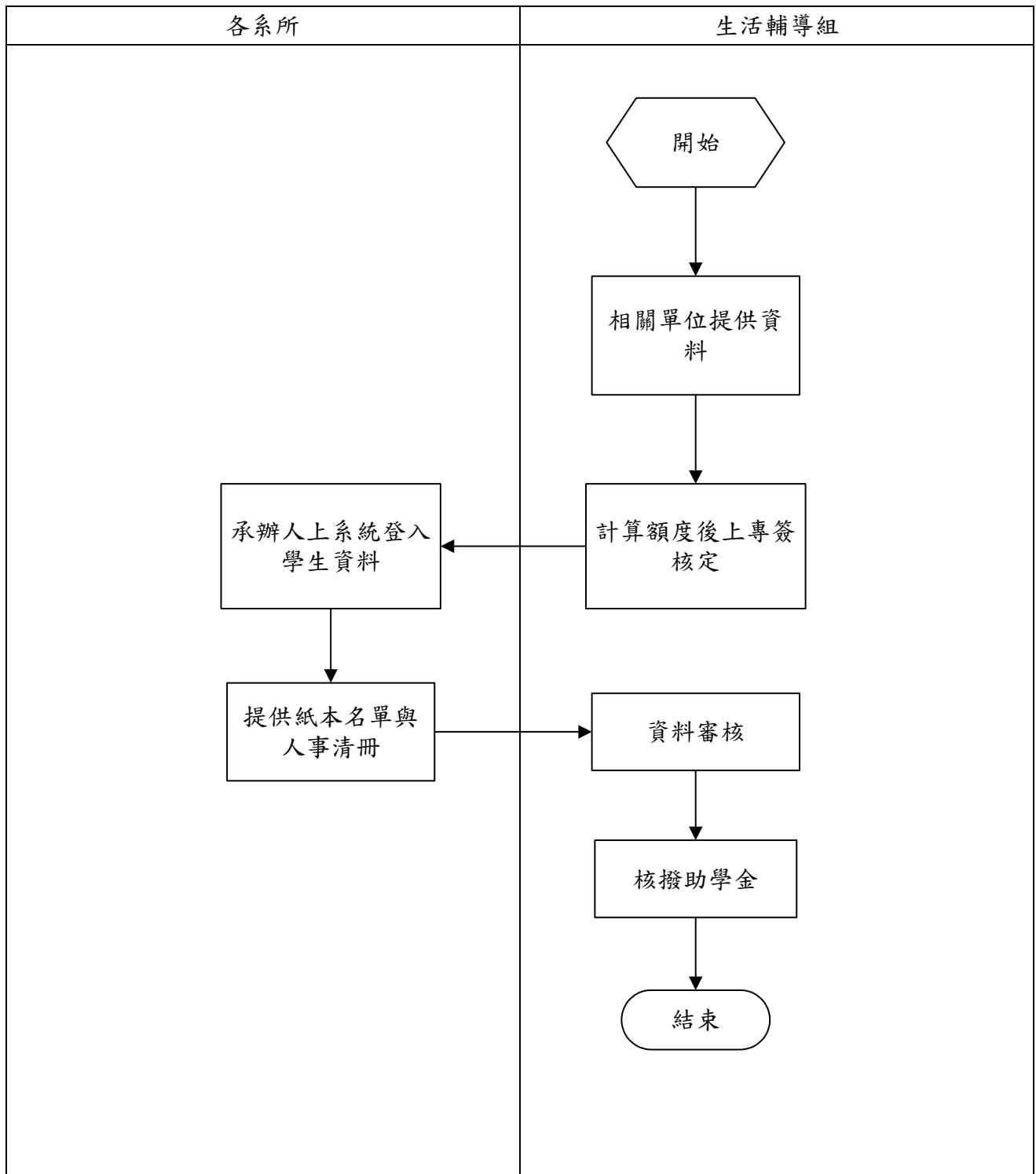

VIII. 校內獎學金核發作業流程圖

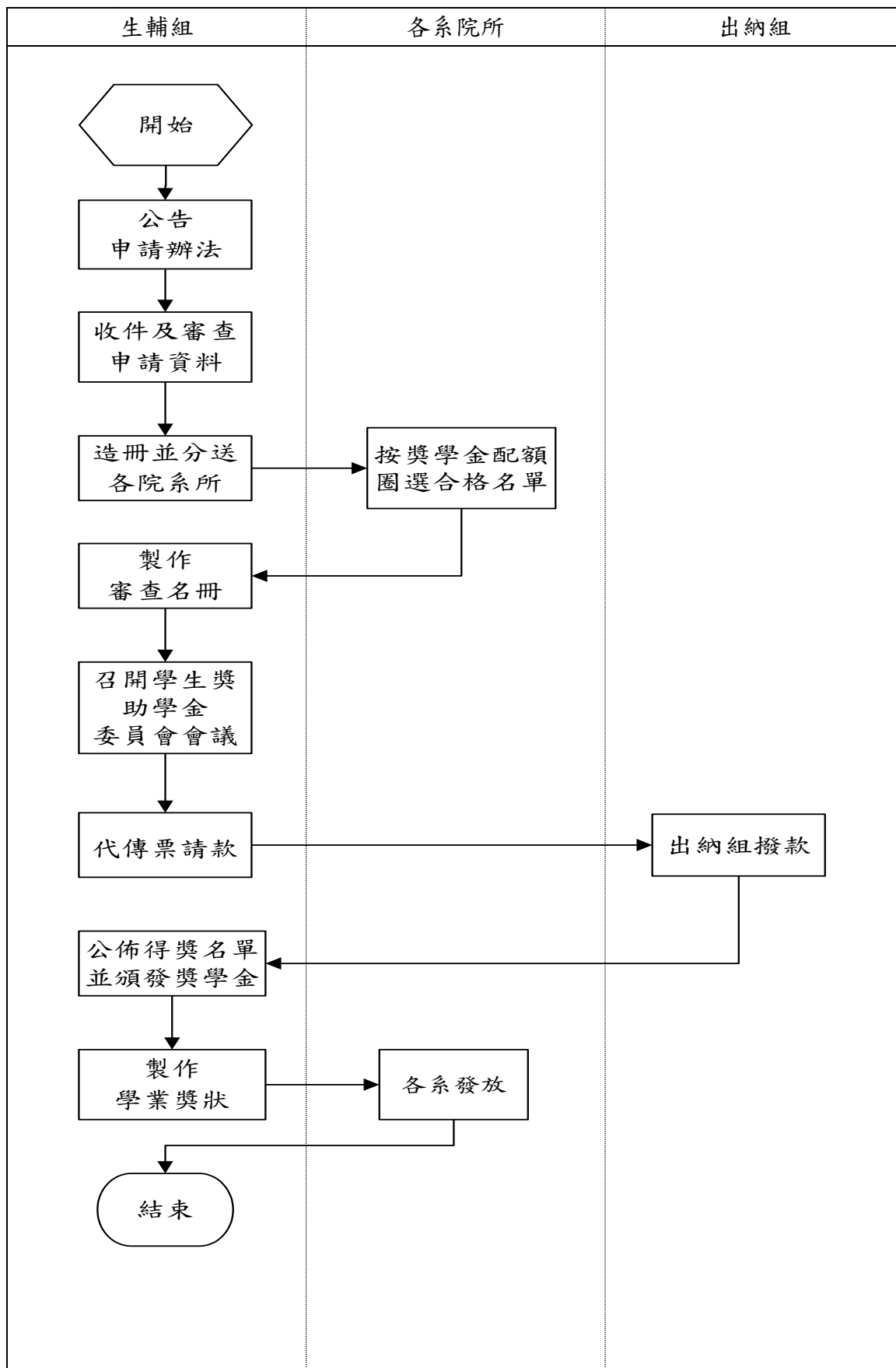

IX. 林壽禎、周秋火、何香、曾正仁獎學基金管理委員會作業流程圖

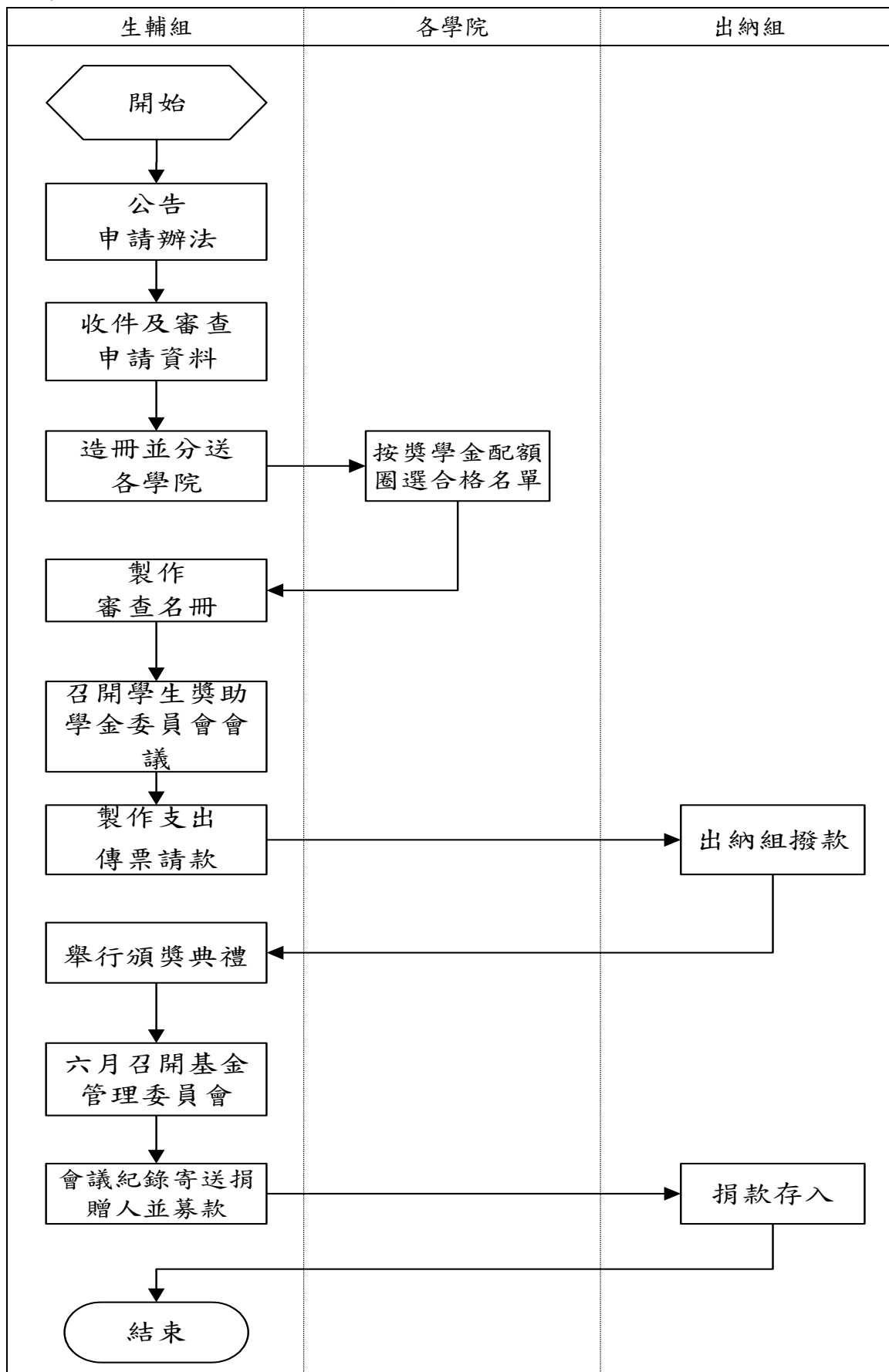

X.陳正炤女士紀念獎學金作業流程圖

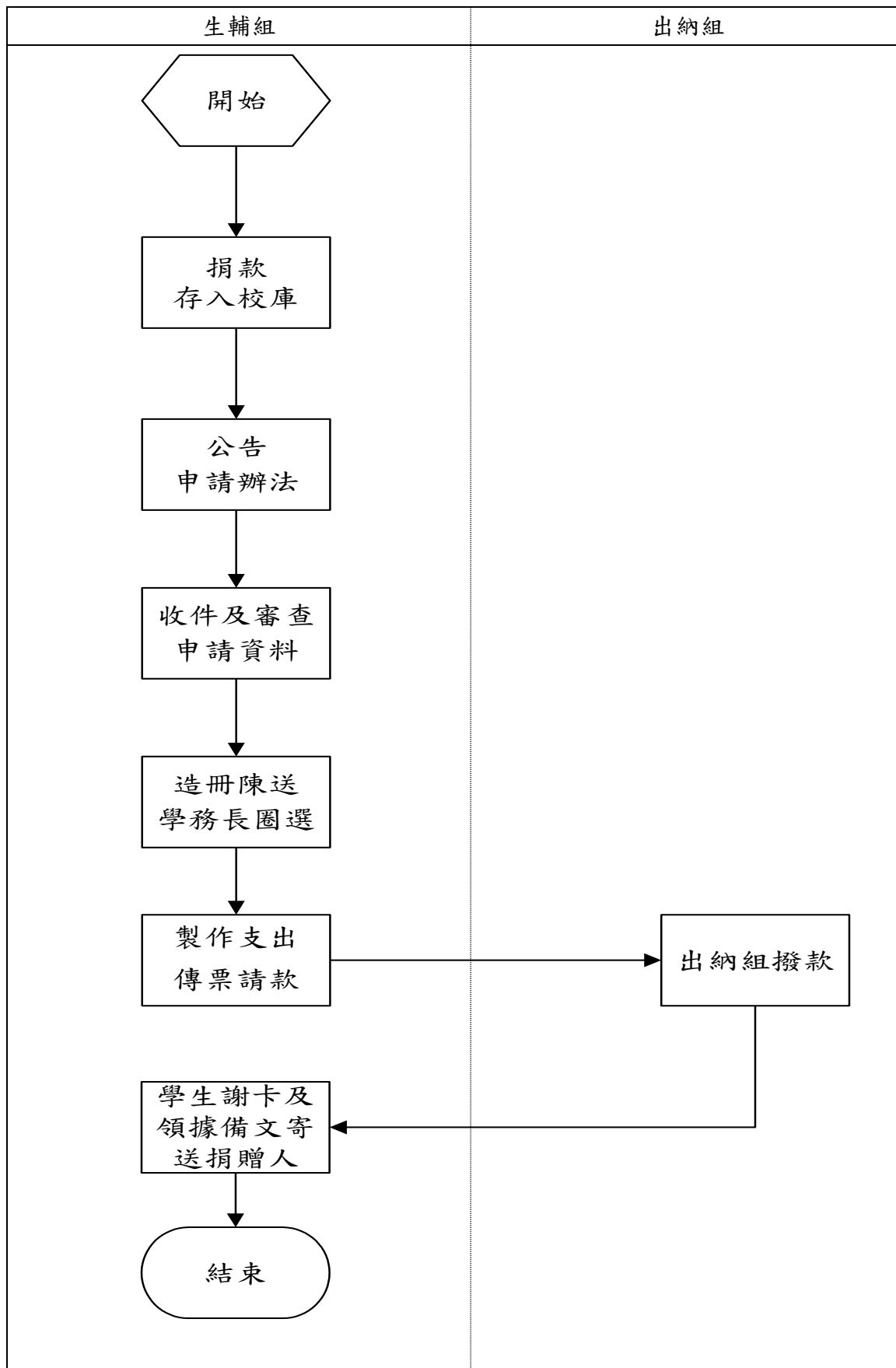

XI. 教育部學產基金設置低收入戶學生助學金作業流程圖

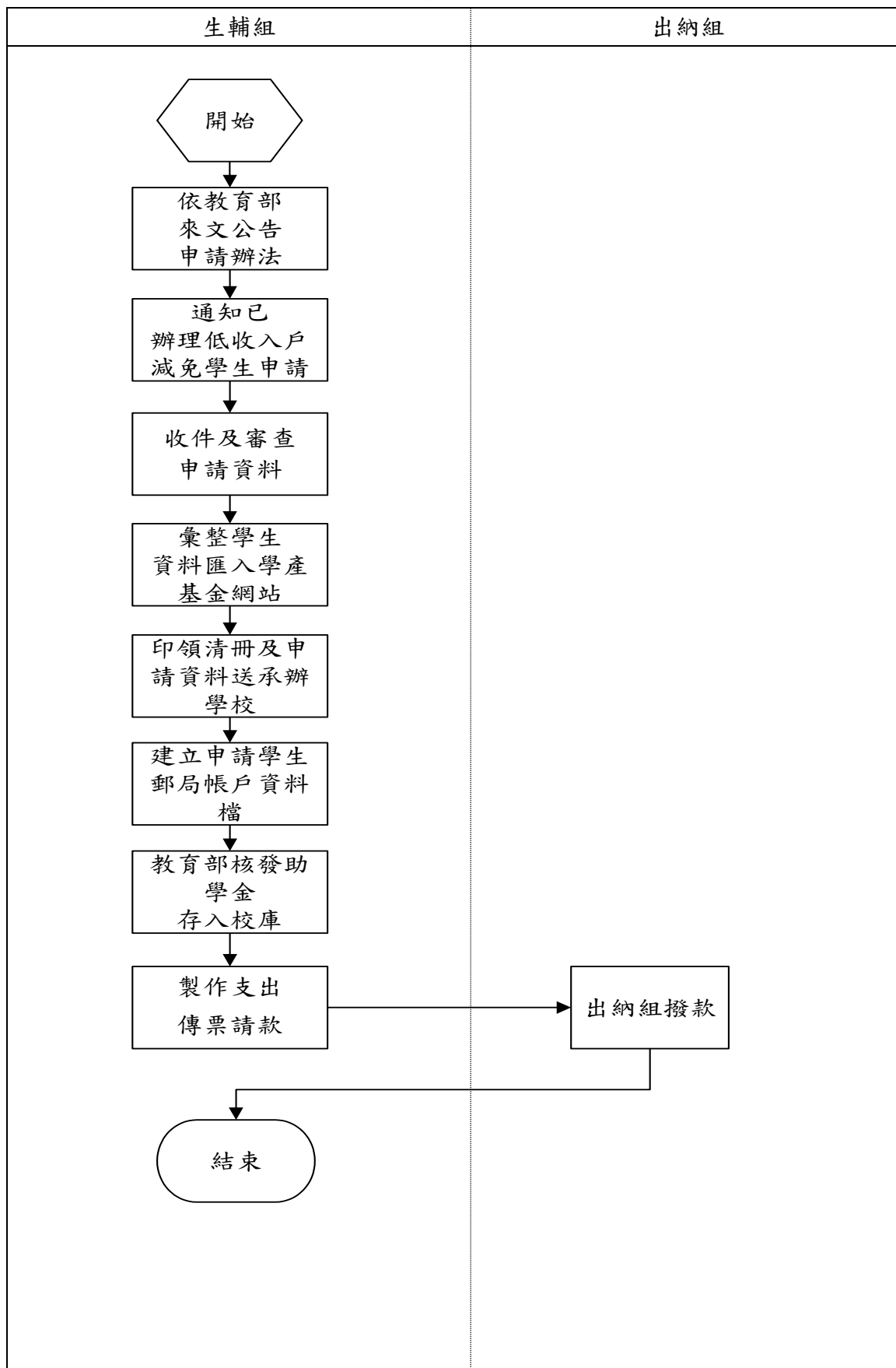

XII. 校外獎學金辦理流程圖

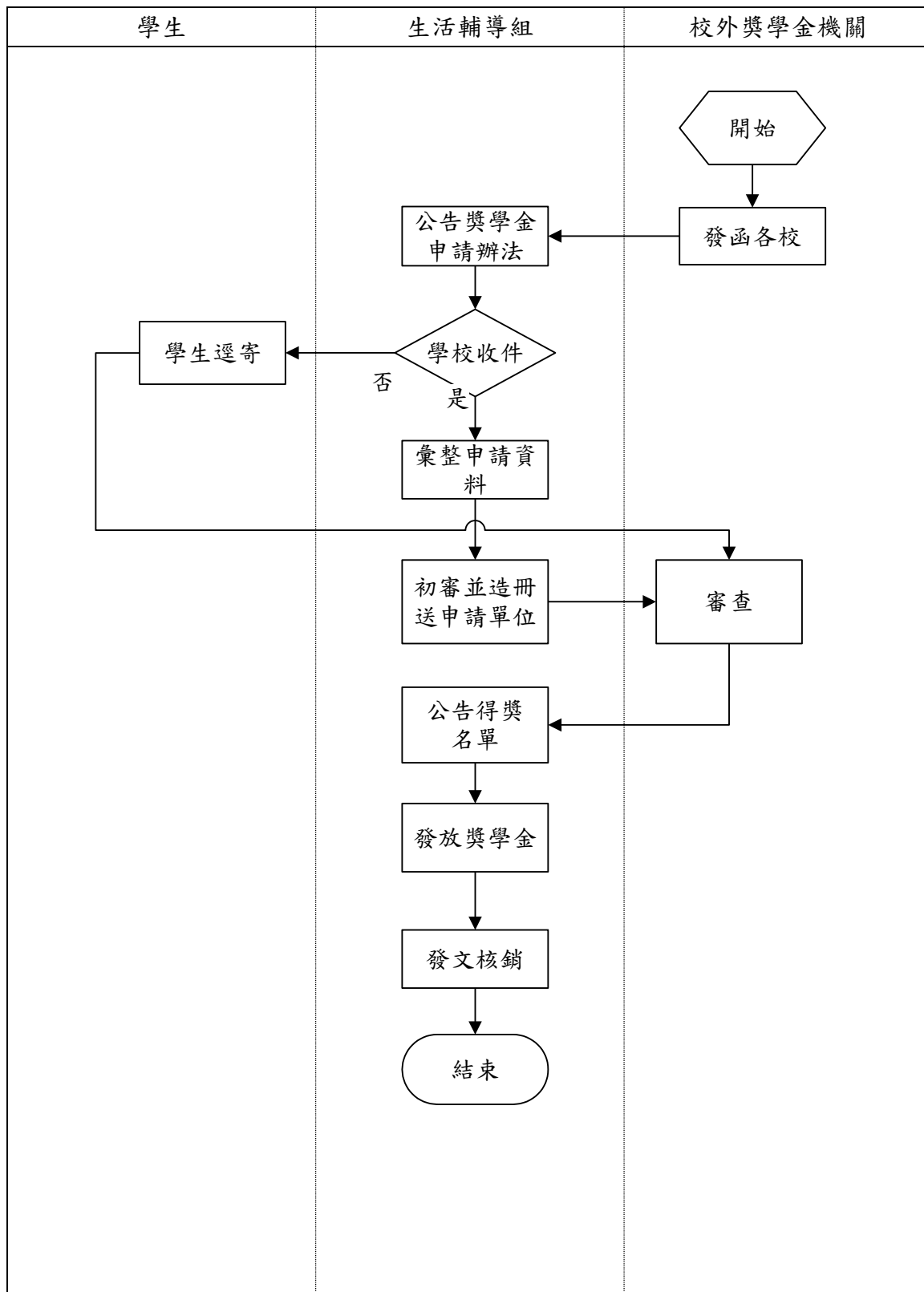

6.各類學生就學優待學雜費減免事項

I.各類學生就學優待學雜費減免作業流程圖-1

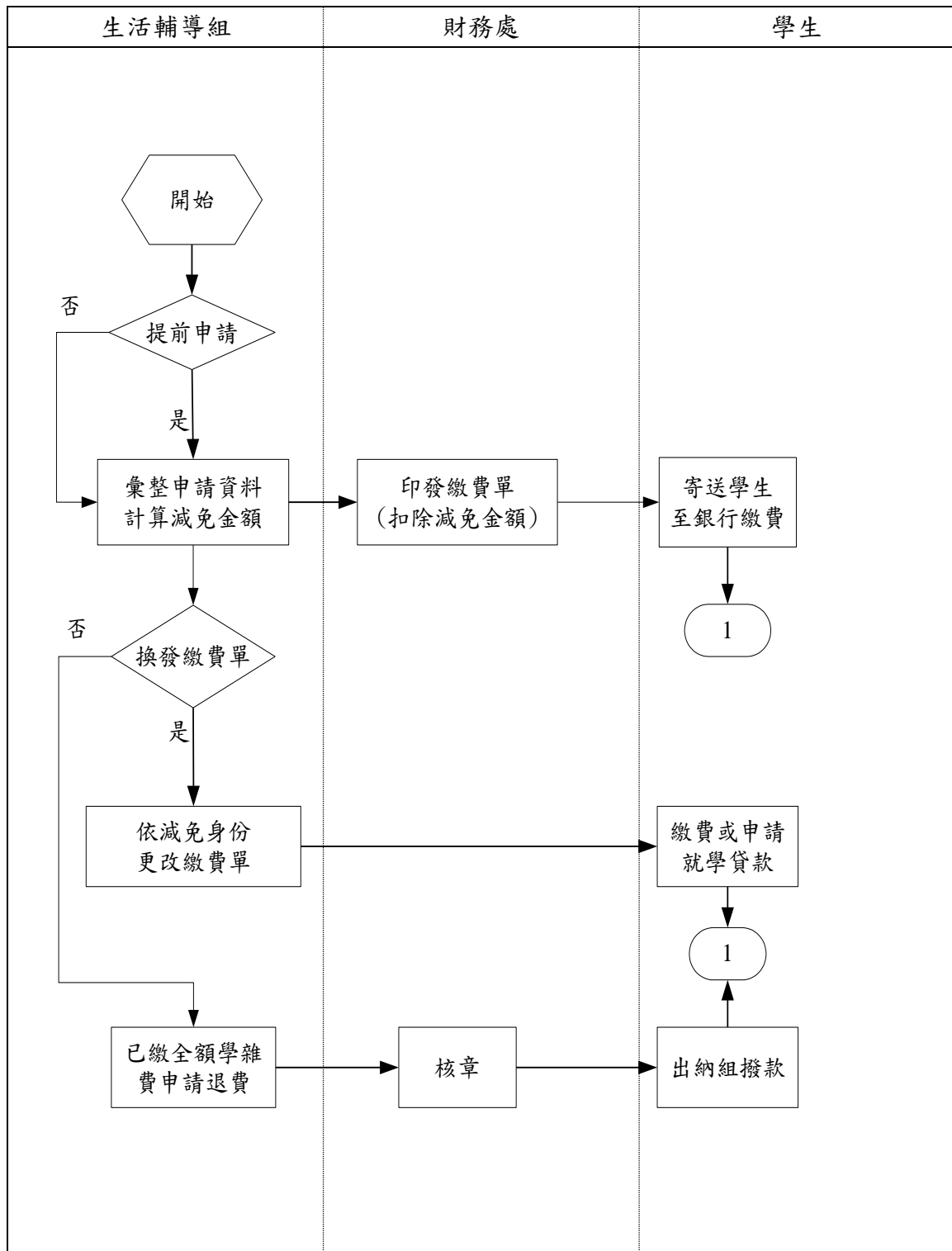

I. 各類學生就學優待學雜費減免作業流程圖-2

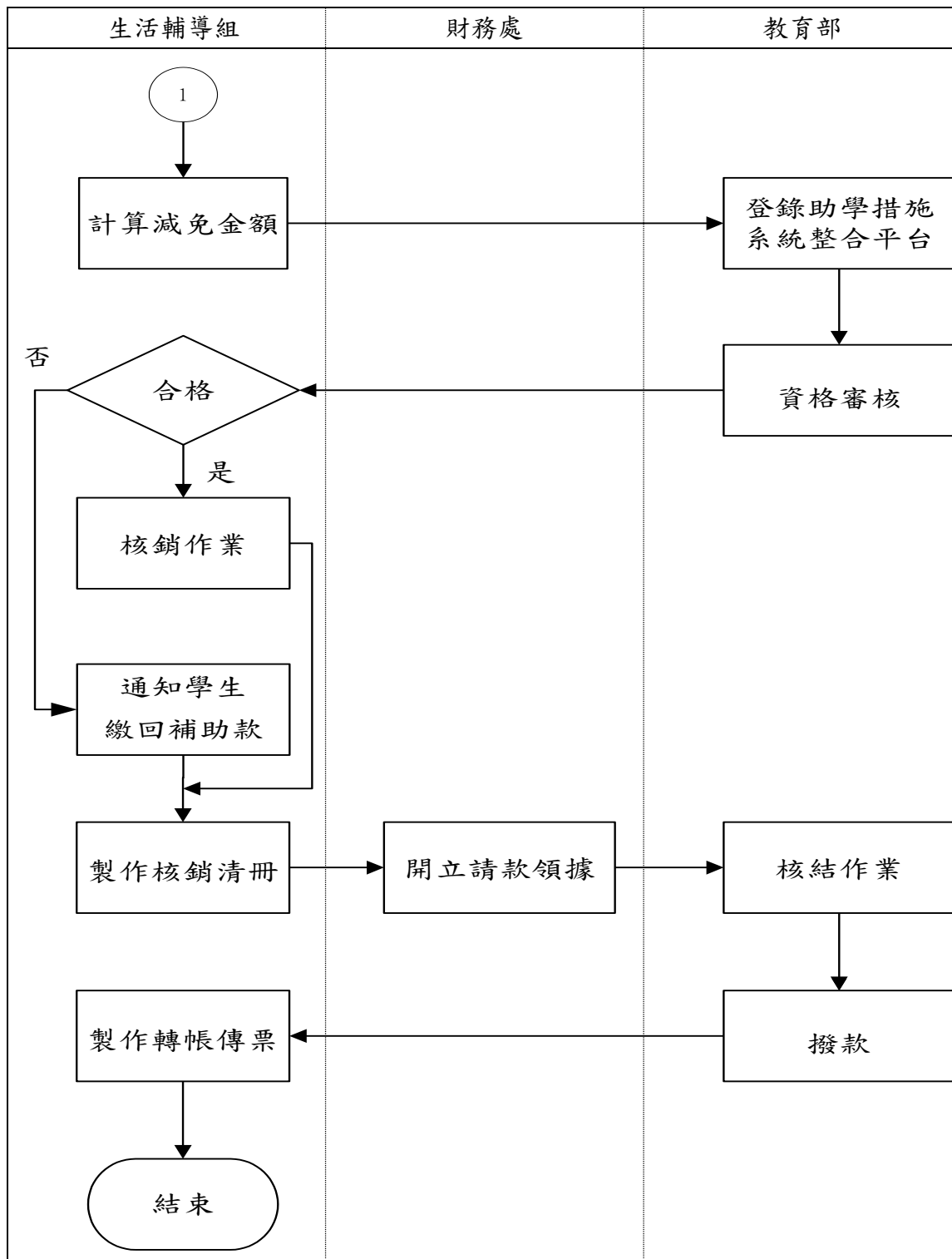

7. 學生請假處理事項

I. 平日假作業流程圖

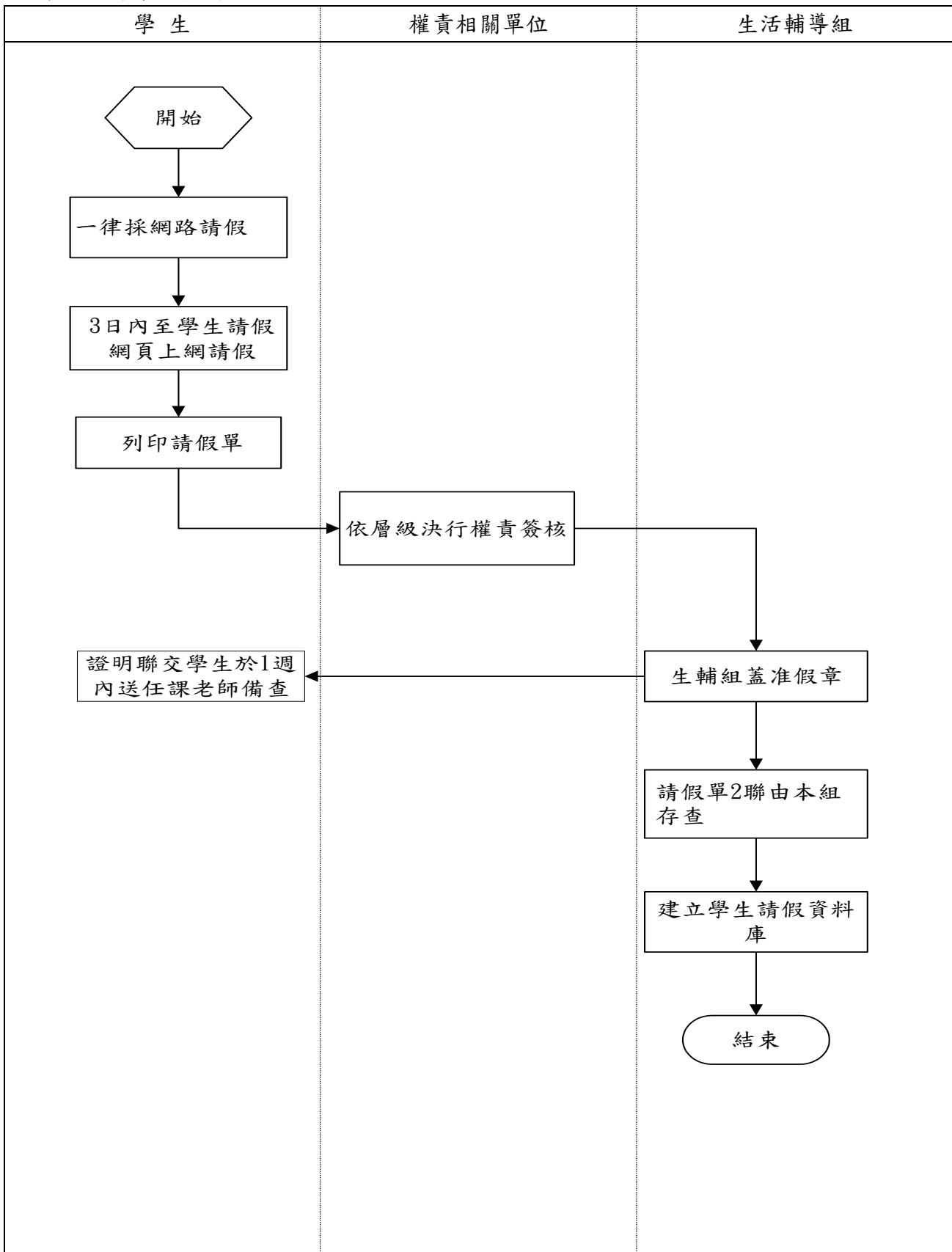

II. 考試假作業流程圖

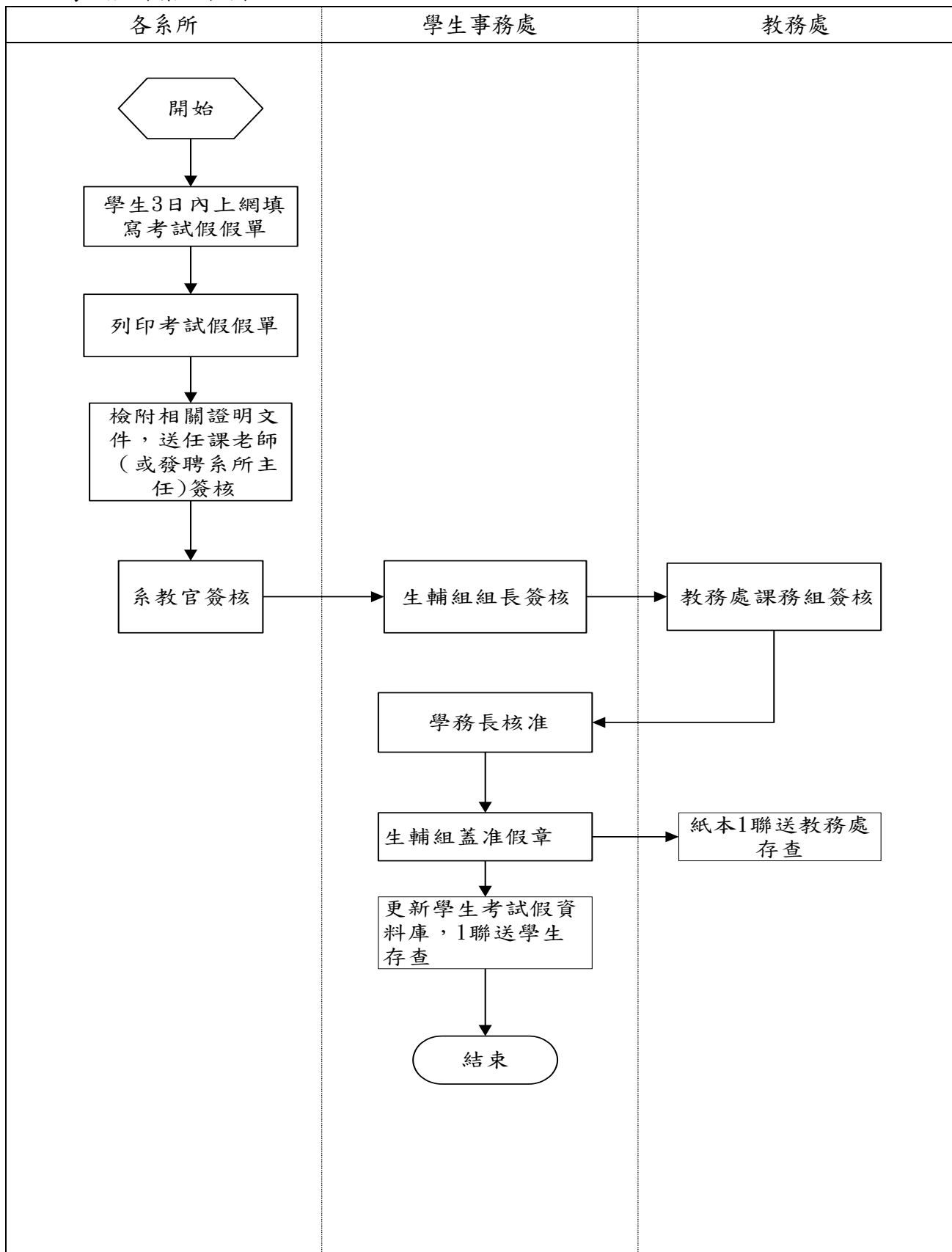

8. 學生獎懲處理及操行成績結算事項

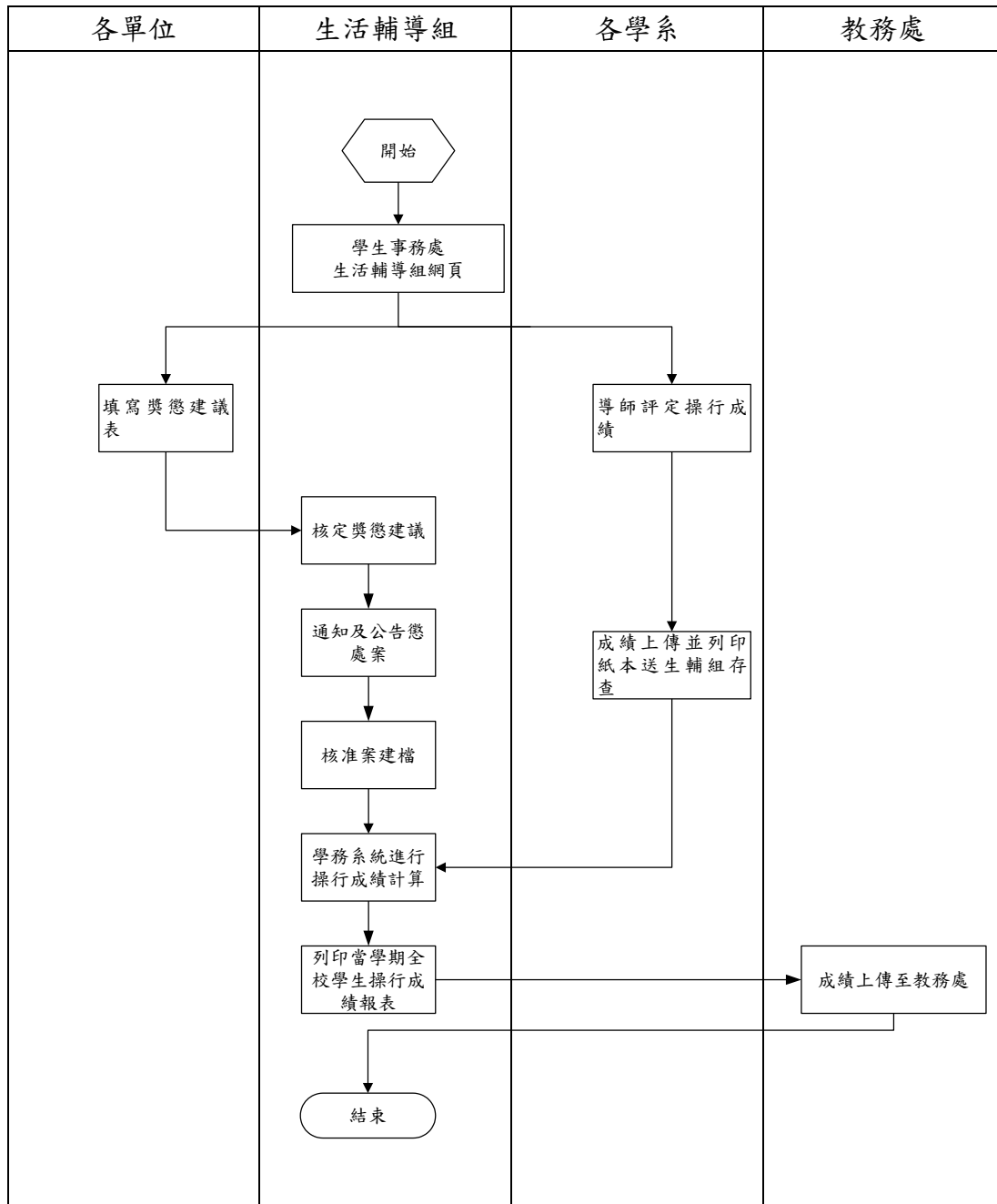

9. 新生入學講習及校慶、畢業典禮籌辦事項

I. 新生入學講習作業流程圖

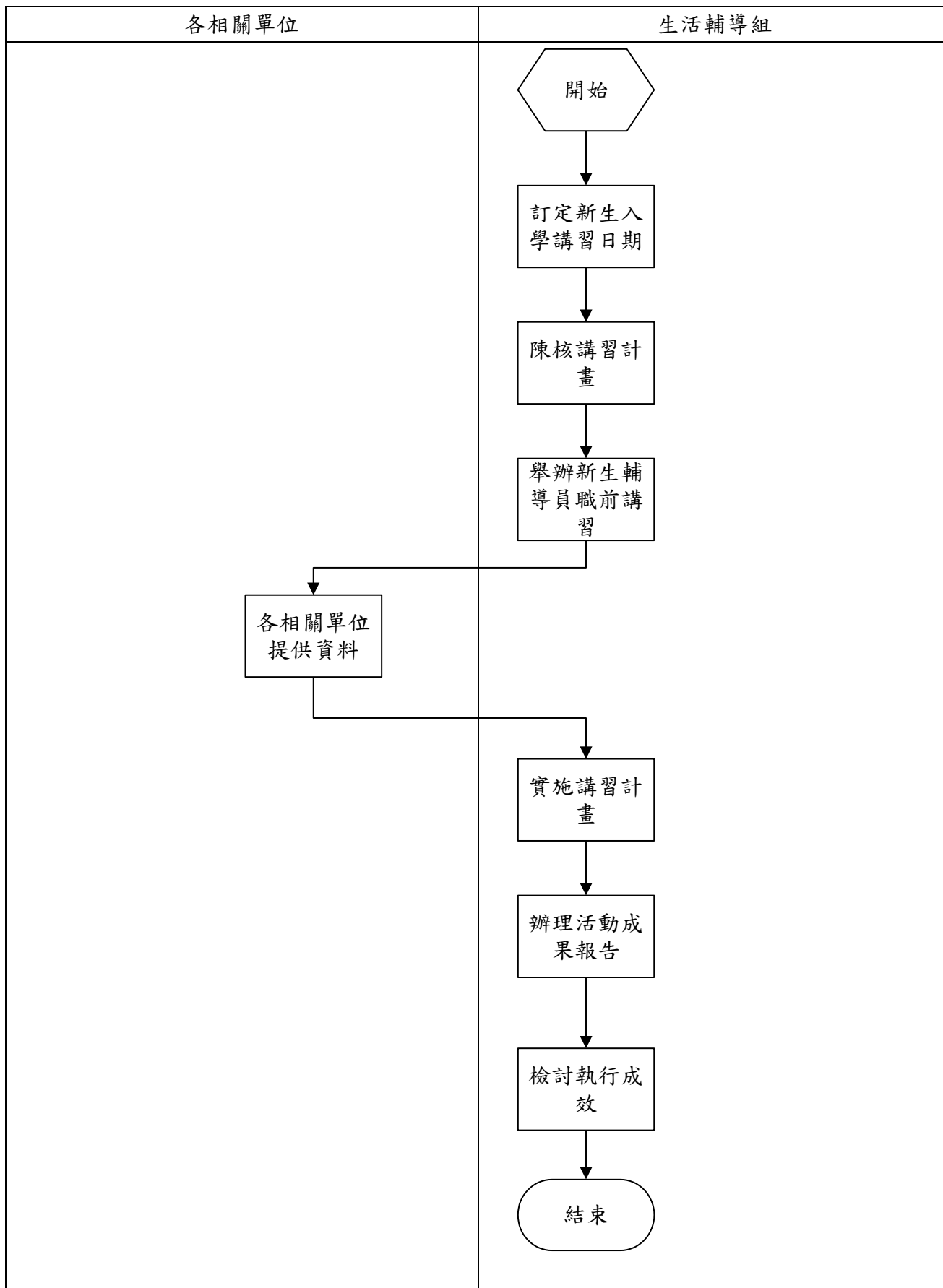

II.校慶慶祝大會作業流程圖

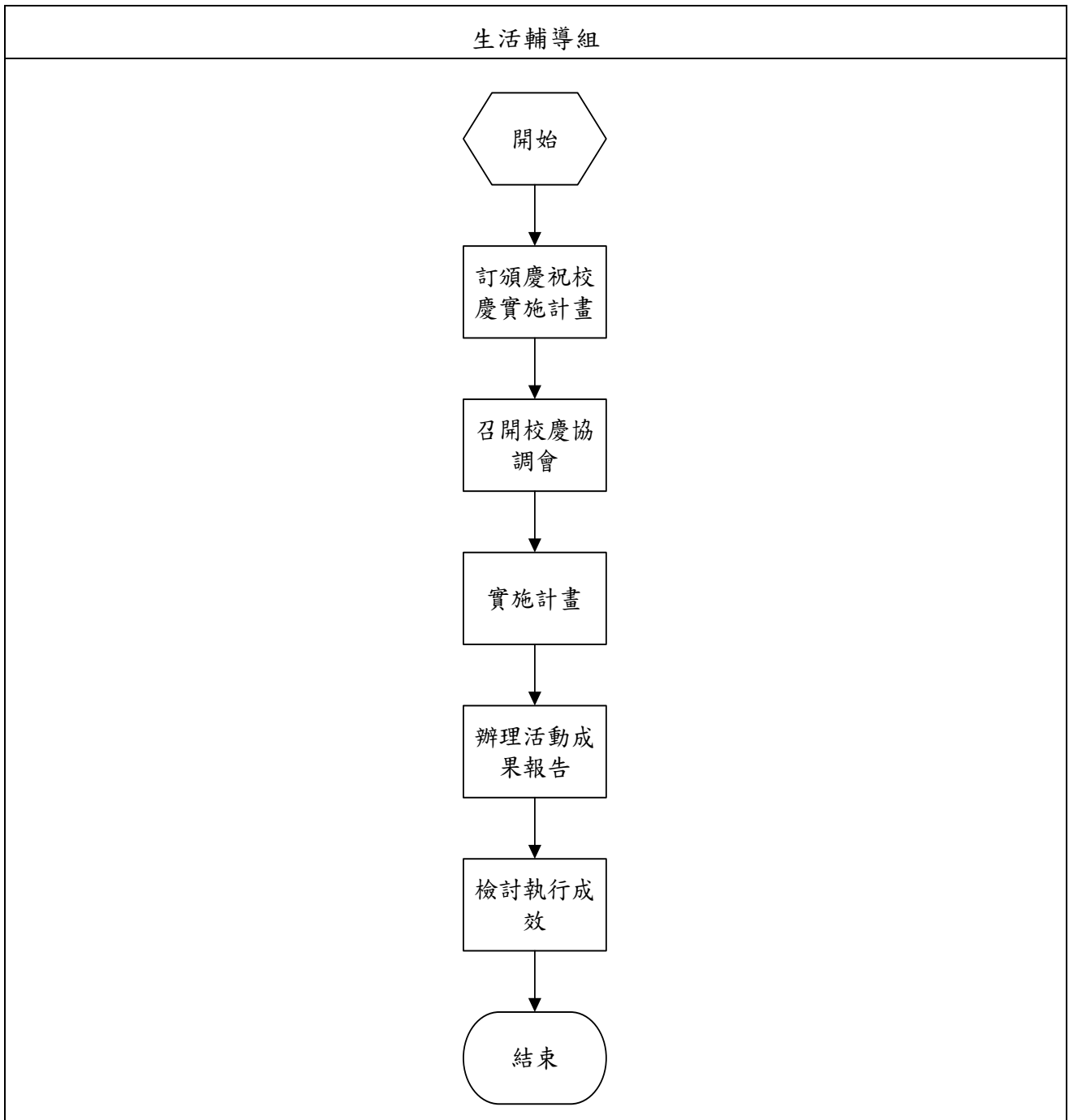

III. 畢業典禮作業流程圖

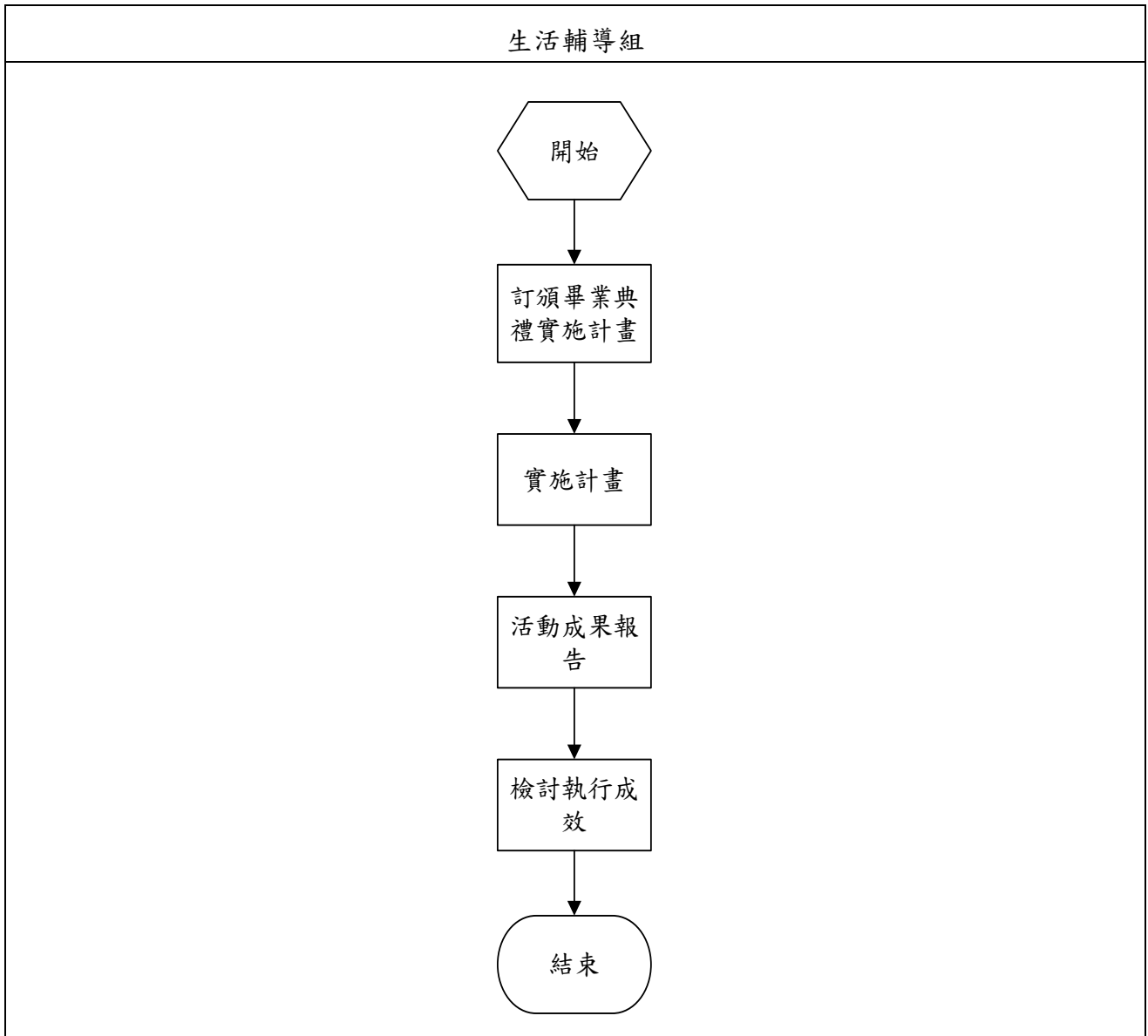

10.學生兵役處理事項

I.兵役緩徵申請暨延長/儘召申請暨延長作業流程圖

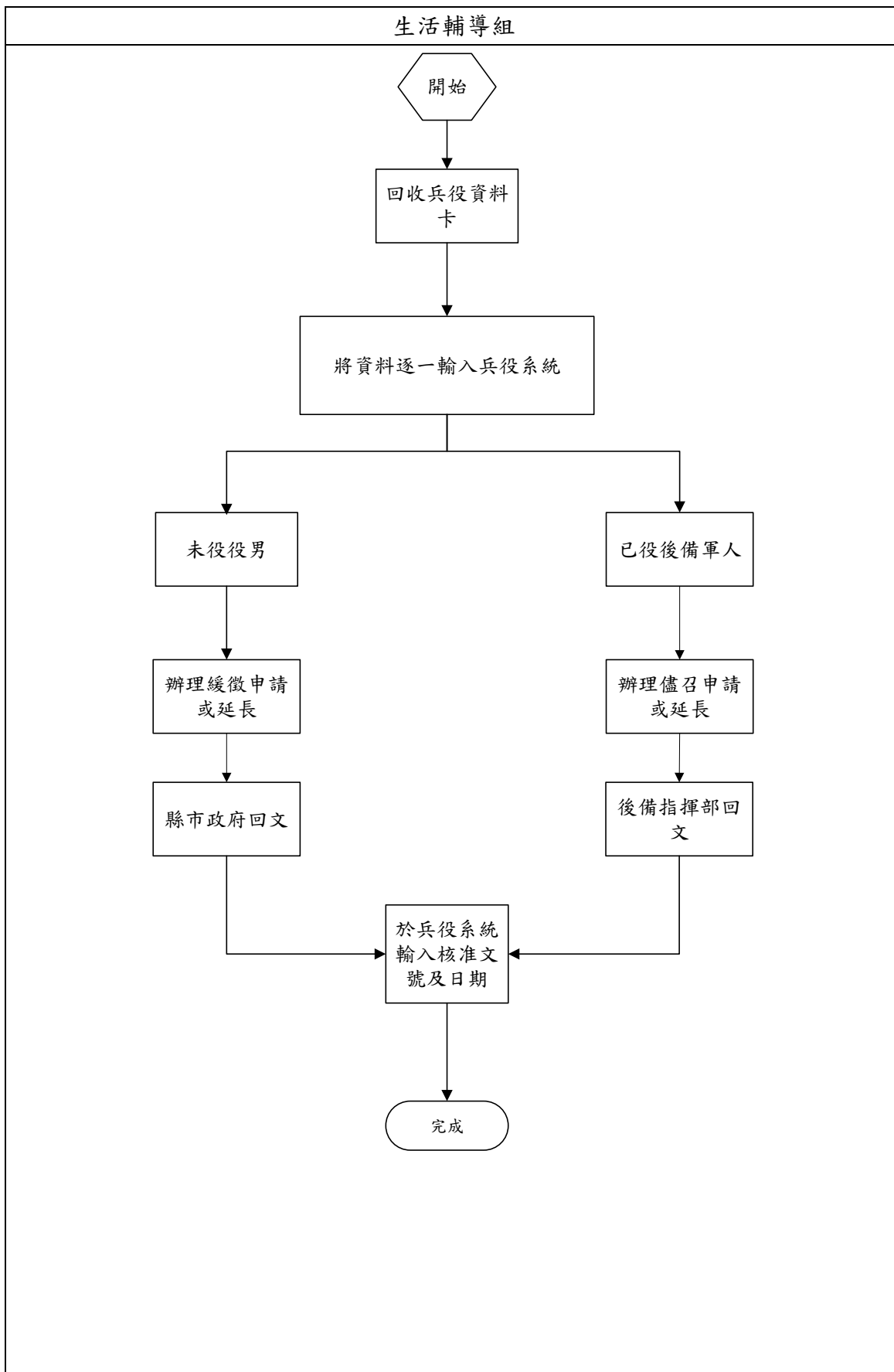

II. 兵役緩徵消滅/儘召消滅作業流程圖

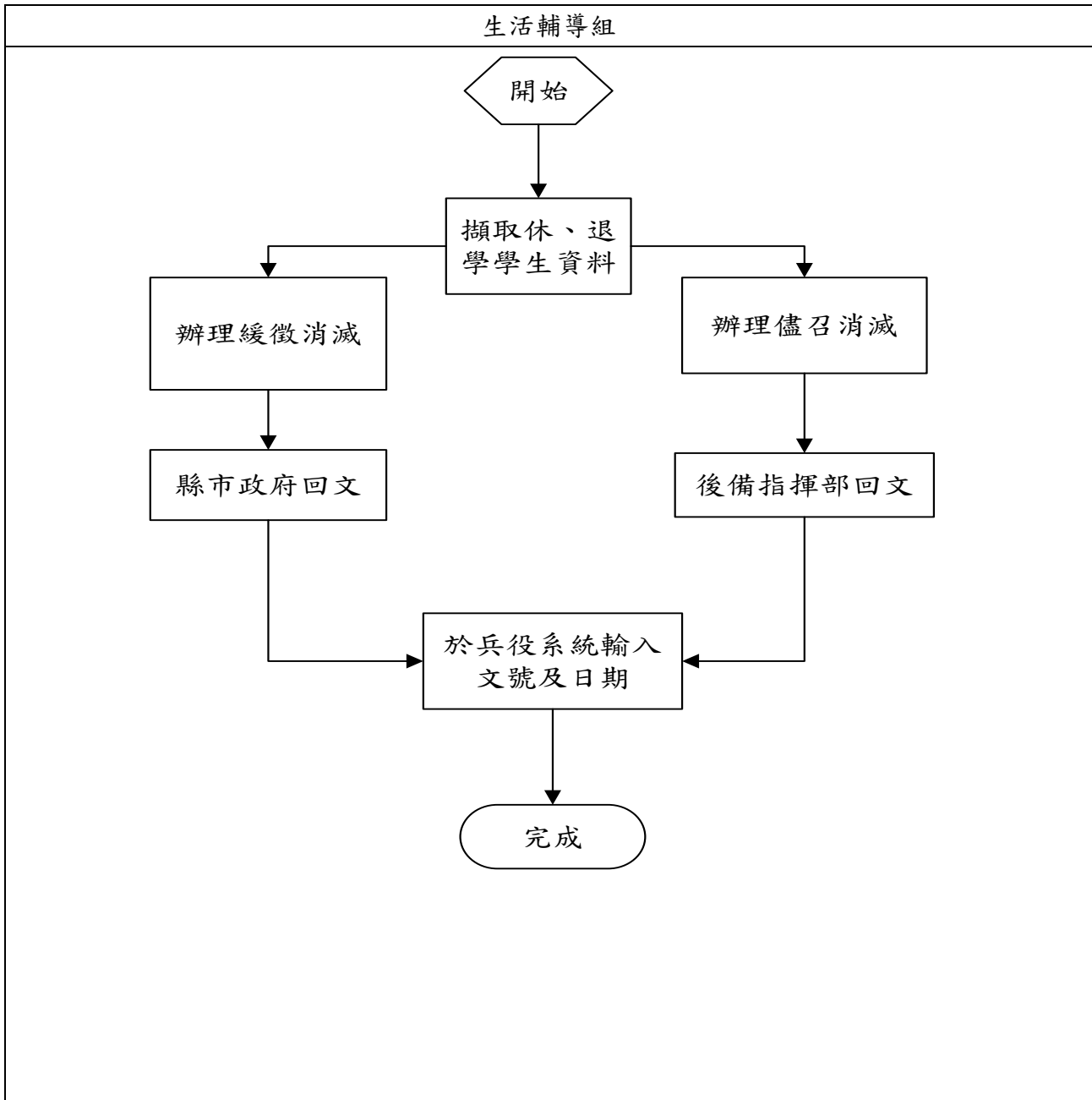

11. 學生專車督導事項

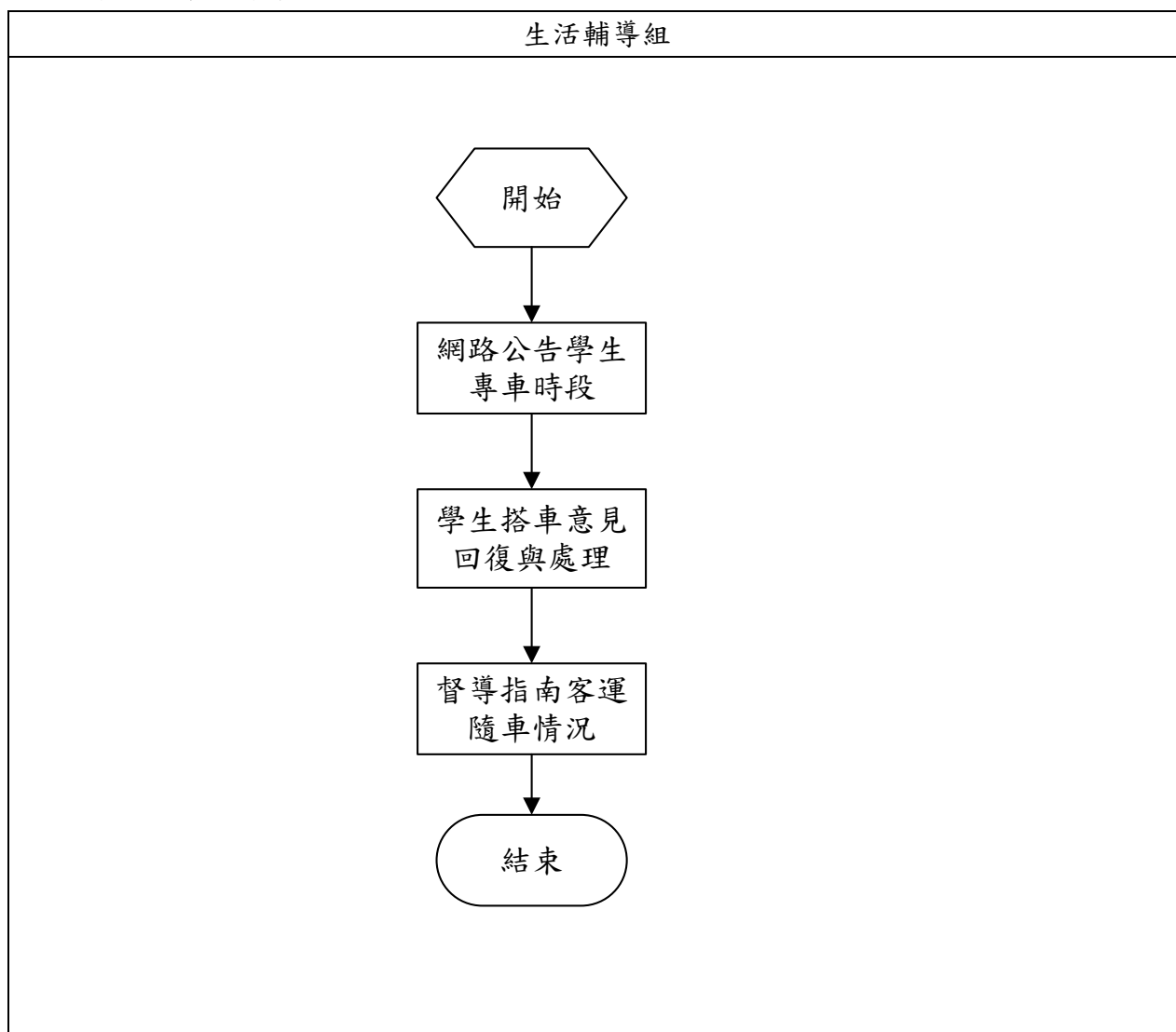

12. 學生團體保險申辦事項

I. 學生團體保險公開評選作業流程圖

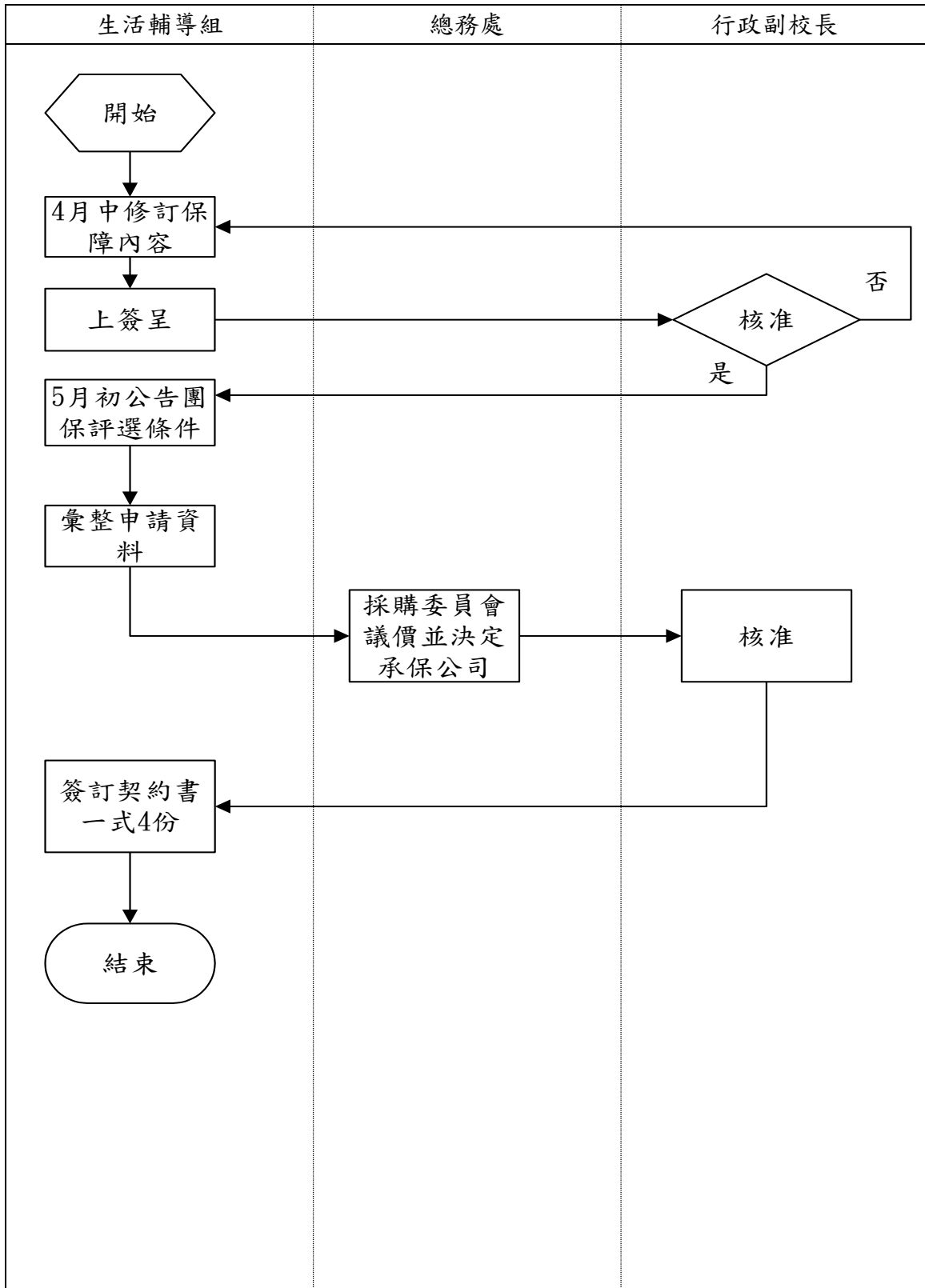

II. 學生團體保險理賠業務流程圖

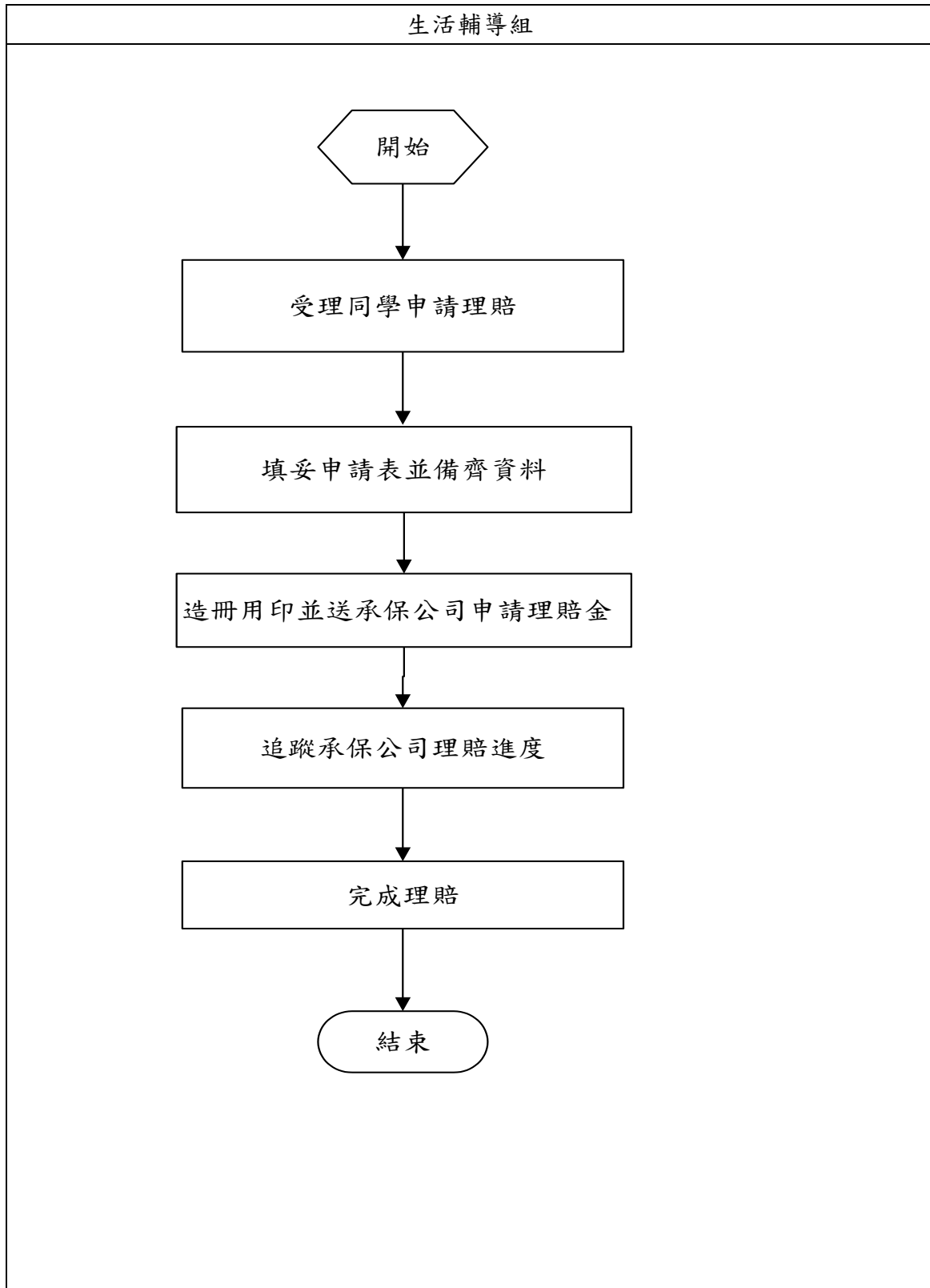

13. 學生就學貸款申辦事項

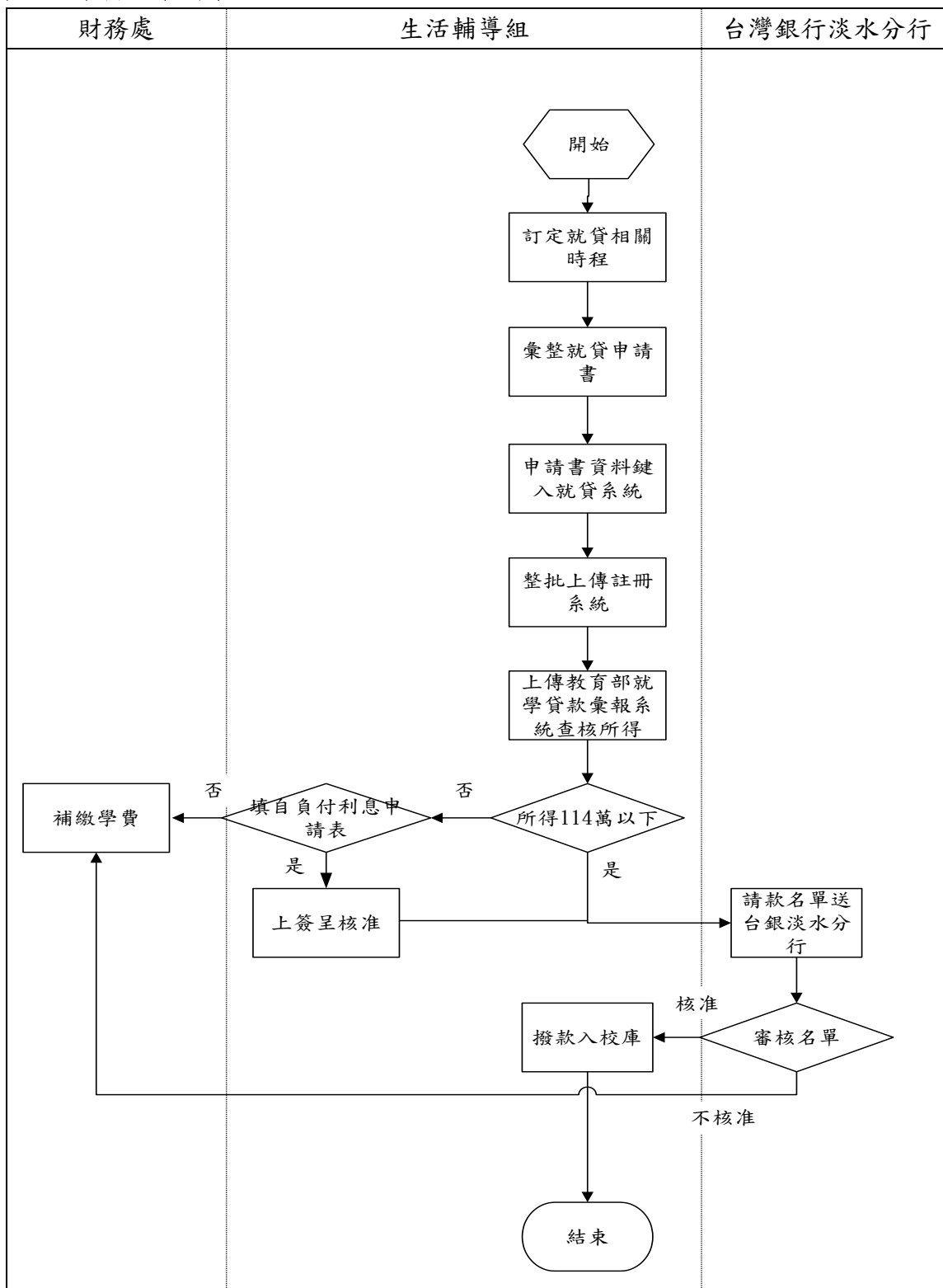

14.防護團常年訓練與防震災演練辦理

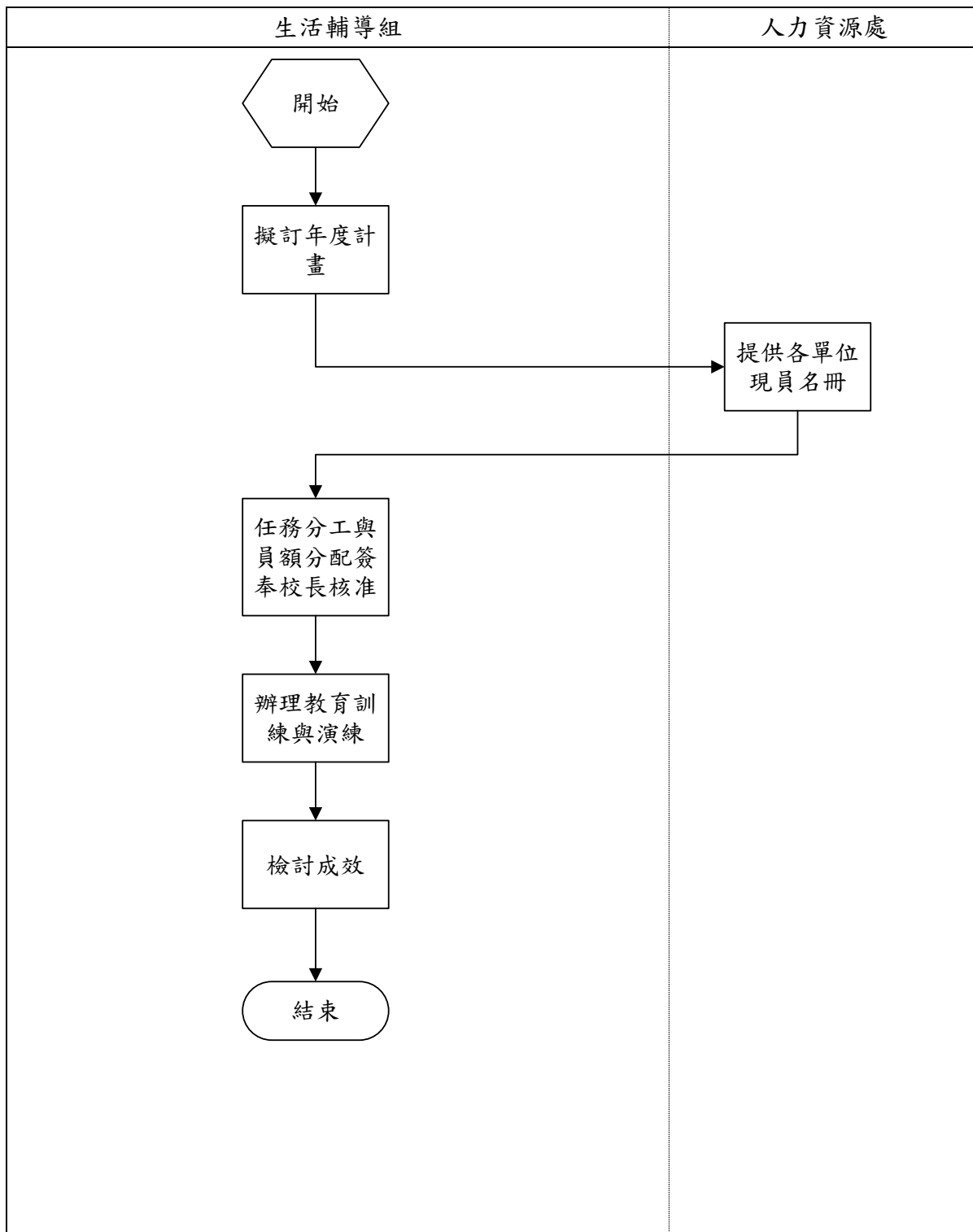

15.通安全教育宣導事項

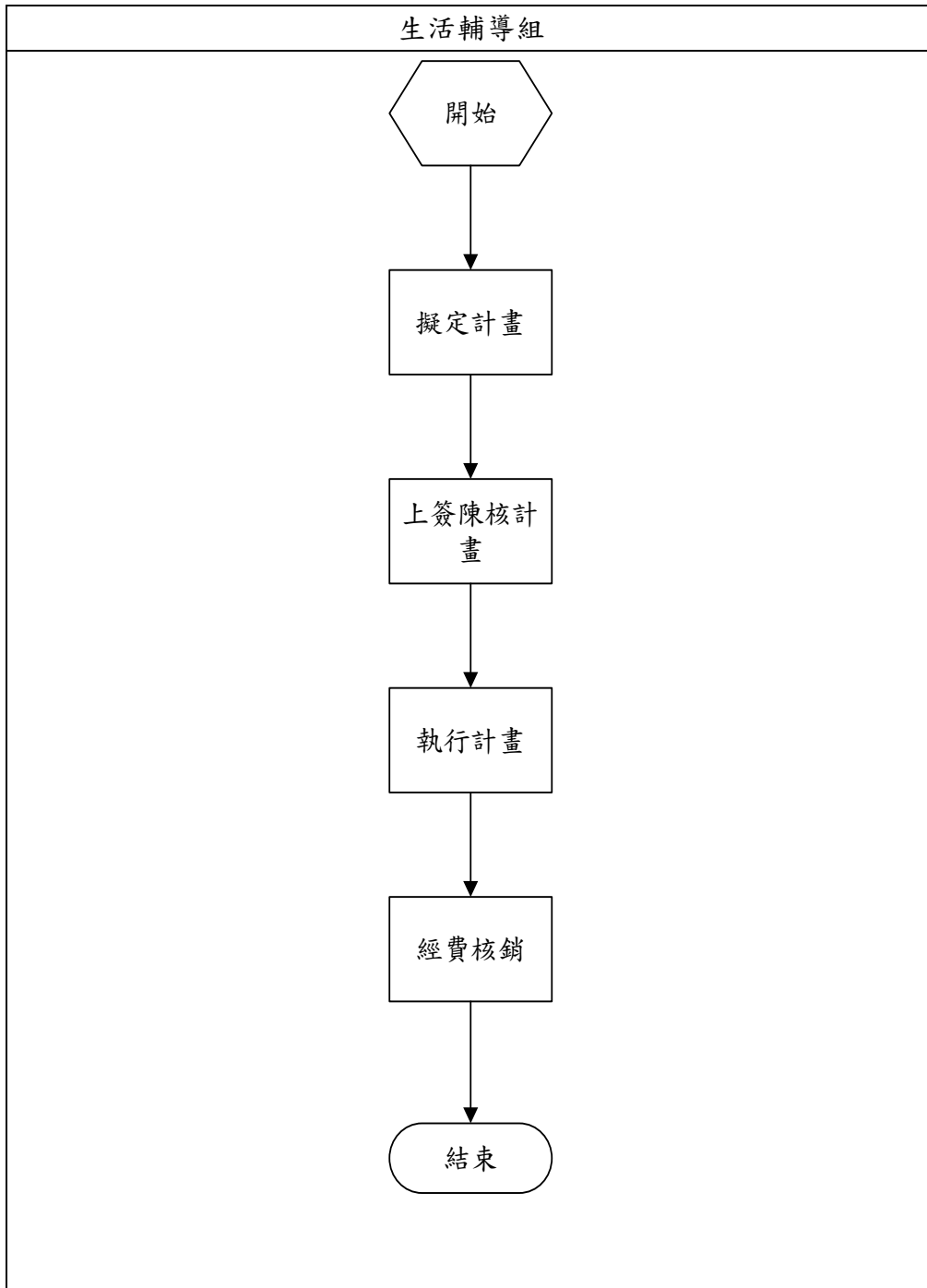

16. 學生申訴受理與評議委員會議召開事項

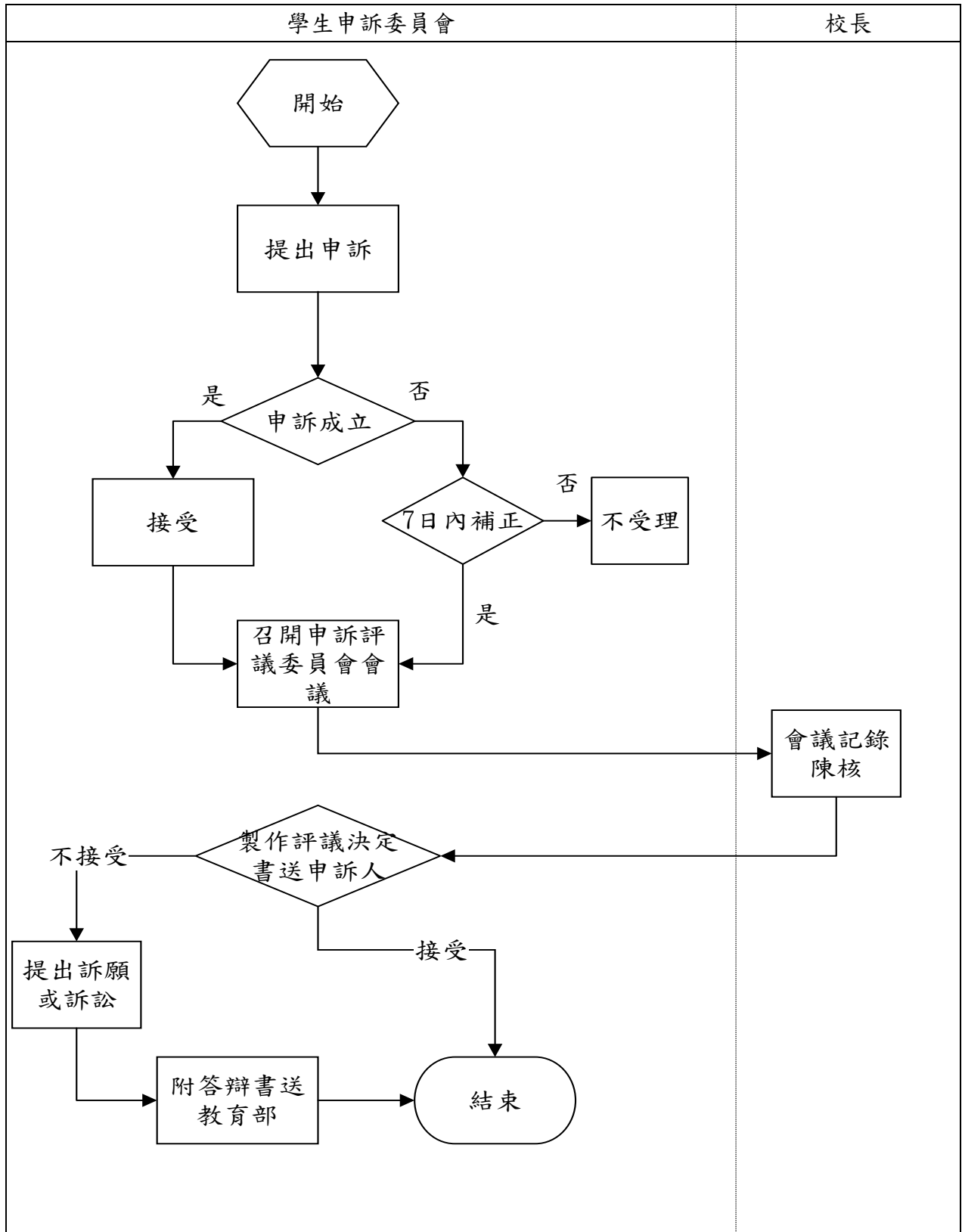

17.新生暨家長座談會事項

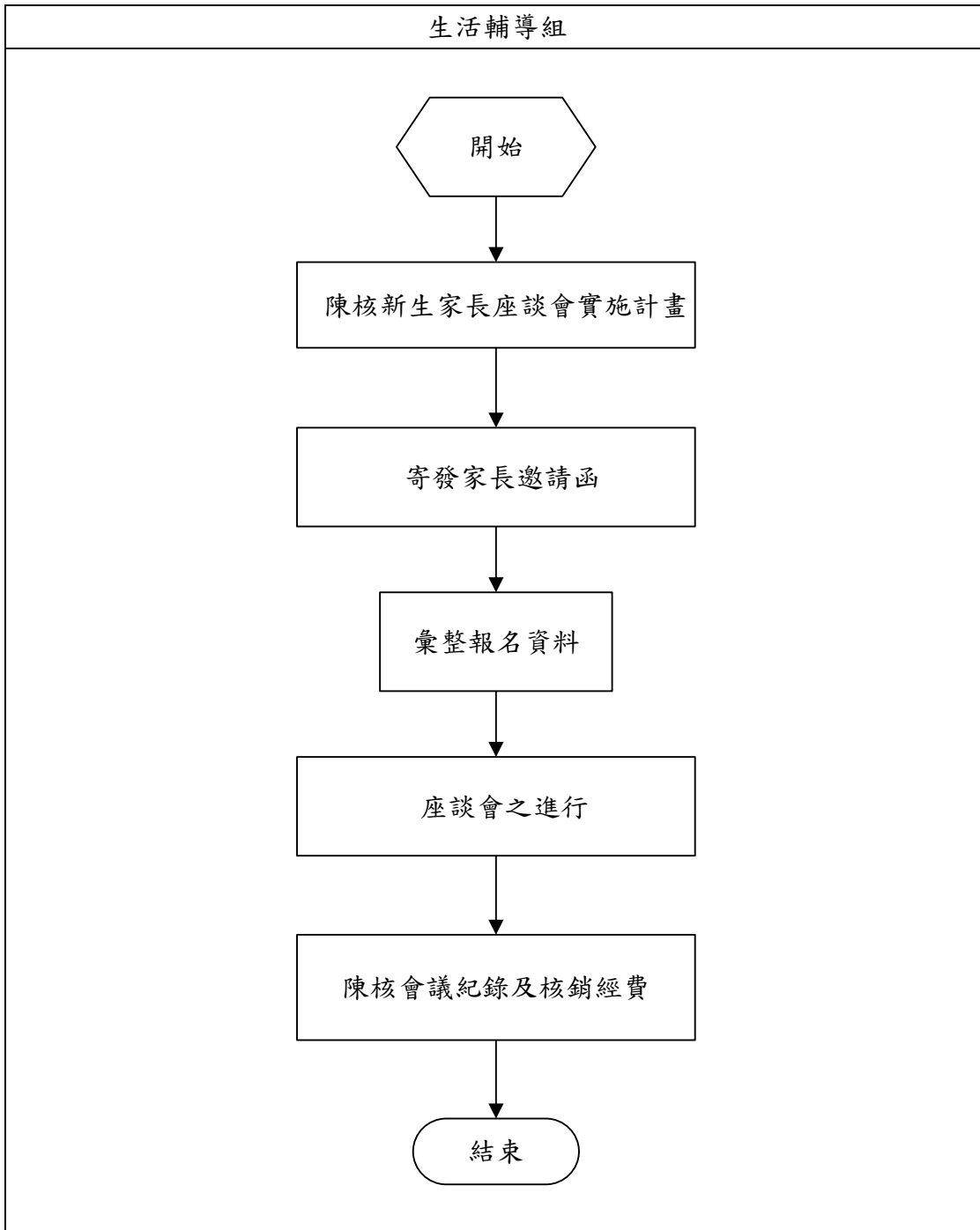

18.全校班代表座談會事項

